

SHARP



R-321CAF(ST)/R-321CAF(BS)

Convection Microwave Oven with grill
OPERATION MANUAL WITH COOKING GUIDE

Read all instructions carefully before using the oven

SHARP WARRANTY

Congratulations on Your Purchase!

This Sharp Microwave Oven is warranted against faults in material and manufacture for 12 months period.

If service is required during the warranty period, please contact your nearest Sharp Approved Service Centre. These repairs would be carried out at no charge to the owner, subject to the conditions specified herein.

This warranty does not extend to defects or injuries caused by or resulting from causes not attributable to faulty parts or the manufacture of the product, including but not limited to, defect or injury caused by or resulting from misuse, abuse, neglect, lack of maintenance, accidental damage, improper voltage, liquid spillage, vermin infestation, software, or any alterations made to the product which are not authorised by Sharp.

Please retain your sales documentation, as this should be produced to validate a warranty claim. This warranty is in addition to and in no way limits, varies or excludes any implied rights and remedies under any relevant legislation in the country of sale.

This warranty does not cover transportation to and from the Sharp Approved Service Centre. Goods presented for repair may be replaced by refurbished goods of the same type rather than being repaired. Refurbished parts may be used to repair the goods. The repair of your goods may result in the loss of user generated data, please ensure that you have saved this data elsewhere prior to repair.

Australian customers: Our goods come with guarantees that cannot be excluded under the Australian Consumer Law. You are entitled to a replacement or refund for a major failure and for compensation for any other reasonably foreseeable loss or damage. You are also entitled to have the goods repaired or replaced if the goods fail to be of acceptable quality and the failure does not amount to a major failure. The criteria of a major failure is defined in the Australian Consumer Law. Should you require any assistance with a major failure please contact Sharp Customer Care.

SHARP

FOR LOCATION ENQUIRIES WITHIN

AUSTRALIA

REGARDING YOUR LOCAL
SHARP APPROVED SERVICE CENTRE
Customer service helplines

1300 742 770

(calling within Australia)

Monday- Saturday, 9am - 6pm

Open Monday to Saturday except on public holidays.

Distributed by
Tempo(Aust) Pty Ltd
PO Box 132 Frenchs Forest NSW 1640 Australia
info@tempo.org
For an electronic copy of this manual, please contact
our after sales support centre.

SHARP

FOR PRODUCTS PURCHASED

NEW ZEALAND

CONTACT YOUR SELLING DEALER/RETAILER
OR CALL

SHARP CUSTOMER SERVICES

TELEPHONE: **09 573 0111**

FACSIMILE: 09 573 0113

WEB:

www.sharp.net.nz

SHARP CORPORATION OF NEW ZEALAND LIMITED

IMPORTANT NOTICE: This warranty applies only to products sold in Australia & New Zealand

INTRODUCTION

SHARP

Thank you for buying a Sharp Microwave Oven. Please keep this operation manual handy, as it describes all the features of your oven and will enable you to cook a variety of foods.

The manual is divided into two sections:

1. OPERATION (P2~P27)
This section describes your oven and teaches you how to use all the features.
2. SMART COOKING GUIDE
This section is at the back of the manual, it contains the more commonly used information such as how to prepare food, which cooking utensil to use and standing times. It also contains recipes for automatic cooking.

Please take some time to read your operation manual carefully, the automatic cooking menus programmed into your new oven have been carefully developed to give optimum results when the step-by-step instructions are followed.

When selecting another home appliance, please again consider our full range of Sharp products.

CONTENTS	Page
Warranty	Inside of front cover
Introduction	1
Important Safety Instructions	2
Special Notes for Microwave	4
Installation Instructions	5
Oven Diagram	6
Operation of Touch Control Panel	7
Control Panel Display	7
Touch Control Panel Layout	7
Before Operating	8
Getting Started	8
Clock Setting	8
Set Timer	9
Stop/Clear	9
To Cancel a Programme During Cooking	9
Manual Operations	10
<Microwave Cooking>	10
Microwave Time Cooking	10,11
Instant Cook	12
<Heating without Food>	13
<Convection Cooking>	14
To Cook by Convection	14
To Preheat and Cook by Convection	15
Convection and Microwave Cooking	16
<Combi Cooking>	17
<Multiple Sequence Cooking>	18,19
<Automatic Menus>	20
Inverter Microwave Cook	20
Fan-Forced Cook	21, 22
Convenience (REHEAT/DEFROST)	23
Convenience (FAVOURITE)	24
Child Lock	25
Mute/Unmute	25
Care and Cleaning	26
Trouble Shooting	26
Service Call Check	27
Specifications	27
Smart Cooking Guides	①-③⑨

IMPORTANT SAFETY INSTRUCTIONS

IMPORTANT SAFETY INSTRUCTIONS: READ CAREFULLY AND KEEP FOR FUTURE REFERENCE.

1. This oven is designed to be used on a countertop, on a shelf, in a cabinet or built-in with a Sharp built-in kit EBR-39ST plus EBR-89ST. We do not recommend installing the oven under the countertop or any other appliances. See page 5 for the installation. Place or mount the oven so that the bottom of the oven is 85cm or more above the floor. The oven door may become hot during cooking. Keep children away from the door to prevent them from burning themselves.
2. Ensure there is a minimum of free space above the oven of 40cm. See page 5 for the other necessary spaces.
3. This appliance is intended to be used in household and similar applications such as:
 - staff kitchen areas in shops, offices and other working environments;
 - farm houses;
 - by clients in hotels, motels and other residential environments;
 - bed and breakfast type environmentsIt is not suitable for commercial or laboratory use.
4. This oven is intended for food preparation and should only be used for heating, cooking and defrosting food and beverages. Drying of food or clothing and heating of warming pads, therapeutic devices (e.g. wheat bags), slippers, sponges, damp cloth and similar may lead to risk of injury, ignition or fire.
5. This appliance is not intended for use by persons (including children) with reduced physical, sensory or mental capabilities, or lack of experience and knowledge, unless they have been given supervision or instruction concerning use of the appliance by a person responsible for their safety.
6. Children should be supervised to ensure that they do not play with the appliance.
7. **WARNING:** Only allow children to use the oven with supervision and when adequate instructions have been given so that the child is able to use the oven in a safe way and understands the hazards of improper use.
8. **WARNING:** Accessible parts may become hot during use. To avoid burns young children should be kept away.
9. **WARNING:** If the door or door seals are damaged, the oven must not be operated until it has been repaired by an authorised SHARP service agent or microwave technician.
10. **WARNING:** Never adjust, repair or modify the oven yourself. It is hazardous for anyone other than an authorised SHARP service agent or microwave technician to carry out any service or repair operation which involves the removal of a cover which gives protection against exposure to microwave energy.
11. If the power supply cord of this appliance is damaged, it must be replaced by a service centre approved by SHARP in order to avoid a hazard.
12. **WARNING:** Liquids and other foods must not be heated in sealed containers since they are liable to explode.
13. Microwave heating of beverages can result in delayed eruptive boiling, therefore care must be taken when handling the container.
14. Eggs in their shell and whole hard-boiled eggs should not be heated on microwave modes since they may explode, even after microwave heating has ended. To cook or reheat eggs which have not been scrambled or mixed, pierce the yolks and the whites, or the eggs may explode. Shell and slice hard boiled eggs before reheating them.
15. Utensils should be checked to ensure that they are suitable for use in the oven. See Page ④. Use only microwave safe containers and utensils on microwave modes.
16. Metallic containers for food and beverages are not allowed during microwave modes.
17. The contents of feeding bottles and baby food jars must be stirred or shaken and the temperature checked before consumption, in order to avoid burns.
18. When heating food in plastic or paper containers, keep an eye on the oven due to the possibility of ignition.
19. If smoke is observed, switch off or unplug the appliance and keep the door closed in order to stifle any flames.
20. The oven should be cleaned regularly and any food deposits removed.
21. Cleaning and user maintenance shall not be performed by children without supervision.
22. Failure to maintain the oven in a clean condition, particularly the inside of the door, cavity and waveguide cover could cause damage and adversely affect the life of the appliance and possibly result in a hazardous situation. This type of damage can void the warranty of the oven.
23. The appliance must not be cleaned with a steam cleaner.
24. See instructions for cleaning door seals, cavities and adjacent parts on page 25.
25. Handle with care when removing items from the oven so that the turntable does not displace.

Other Warnings

1. Whenever the grill or convection symbol is displayed, the turntable, roller stay, racks, grill tray, oven door, outer cabinet and oven cavity will become very hot.
To prevent yourself from getting burnt, use thick oven mittens.
Do not put things on top of the oven or cover the outer cabinet.
Accessible parts (eg. oven door, turntable, racks and grill tray) will become hot when in use.
To avoid burns and scalds, children should be kept away.
2. To reduce the risk of fire in the oven cavity:
 - a. Do not overcook food.
 - b. Remove wire twist-ties from paper or plastic bags before placing bag in the oven.
 - c. Do not heat oil or fat for deep frying by microwave. The temperature of the oil cannot be controlled.
3. To reduce the risk of an explosion or delayed eruptive boiling, care should be taken when handling the food and container. Your oven is capable of heating food and beverages very quickly with microwaves, therefore it is very important that you select the appropriate cooking time and power level for the type and quantity of food to be heated. If you are unsure of the cooking time and power level required, begin with low cooking times and power levels until the food is sufficiently heated evenly throughout.
Additionally:
 - a. Do not place sealed containers in the microwave. Baby bottles fitted with a screw cap or teat are considered to be sealed containers.
 - b. Do not use excessive amounts of cooking time.
 - c. When boiling liquids in the oven, use a wide-mouthed container.
 - d. Stand for at least 20 seconds at the end of cooking to avoid delayed eruptive boiling of liquids.
 - e. Stir the liquid before and during cooking. Use extreme care when handling the container or inserting a spoon or other utensil into the container.
4. Never operate the oven whilst any object is caught or jammed between the door and the oven.
5. Handle with care when removing items from the oven so that the utensil, your clothes or accessories do not touch the latches.
6. Never poke an object, particularly a metal object, through the door or in the oven while the oven is operating.
7. Never tamper with or deactivate the door safety latches.
8. Always use oven gloves to prevent burns when handling utensils that are in contact with hot food.
Enough heat from the food can transfer through utensils to cause skin burns.
9. If the oven lamp fails please consult your dealer or a qualified service technician trained by SHARP.
10. Avoid steam burns by directing steam away from the face and hands. Slowly lift the furthest edge of a dish's cover including microwave plastic wrap etc., and carefully open popcorn and oven cooking bags directed away from the face.
11. Make sure that the power supply cord is undamaged, and that it does not run under the oven or over any hot surfaces or sharp edges.
12. To prevent the turntable from breaking:
 - a. Before cleaning the turntable with water, leave the turntable to cool.
 - b. Do not place anything hot on a cold turntable.
 - c. Do not place anything cold on a hot turntable.
13. Do not place anything on the outer cabinet.
14. Do not store food or any other items inside the oven.
15. Make sure the utensil does not touch the interior walls during cooking.

Information on Disposal

This product should not be disposed of in a general waste bin as it contains materials that should be recycled, which is good for the environment.

If you are in doubt about the correct disposal method, contact your local council.

The accessible surface may be hot during operation.





SPECIAL NOTES FOR MICROWAVE

	DO	DON'T
Eggs, fruits, nuts, seeds, vegetables, sausages and oysters	<ul style="list-style-type: none"> * Puncture egg yolks and whites and oysters before cooking to prevent "explosion". * Pierce skins of potatoes, apples, squash, hot dogs, sausages and oysters so that steam escapes. 	<ul style="list-style-type: none"> * Cook eggs in shells. This can cause the egg to "explode", which may damage the oven or cause injury to yourself. * Cook hard/soft boiled eggs. * Overcook oysters. * Dry nuts or seeds in shells.
Popcorn	<ul style="list-style-type: none"> * Use specially bagged popcorn for the microwave oven. * Listen while popping corn for the popping to slow to 1-2 seconds. 	<ul style="list-style-type: none"> * Pop popcorn in regular brown bags or glass bowls. * Exceed maximum time on popcorn package.
Baby food	<ul style="list-style-type: none"> * Transfer baby food to a small dish and heat carefully, stirring often. Check for suitable temperature to prevent burns. * Remove the screw cap and teat before warming baby bottles. After warming shake thoroughly. Check for suitable temperature. 	<ul style="list-style-type: none"> * Heat disposable bottles. * Overheat baby bottles. Only heat until warm. * Heat bottles with teats on. * Heat baby food in original jars.
General	<ul style="list-style-type: none"> * Food with filling should be cut after heating, to release steam and avoid burns. * Use a deep bowl when cooking liquids or cereals to prevent boiling over. 	<ul style="list-style-type: none"> * Heat or cook in closed glass jars or air tight containers. * Deep fry fat. * Heat or dry wood, herbs, wet papers, clothes or flowers. * Operate the oven without a load (i.e. an absorbing material such as food or water) in the oven cavity except when conditioning or cleaning the heater elements as described in the operation manual.
Liquids (Beverages)	<ul style="list-style-type: none"> * For boiling or cooking liquids see IMPORTANT SAFETY INSTRUCTIONS on page 2 to prevent explosion and delayed eruptive boiling. 	<ul style="list-style-type: none"> * Heat for longer than recommended time. See REHEATING-FOOD CHART on page 37.
Canned foods	<ul style="list-style-type: none"> * Remove food from can. 	<ul style="list-style-type: none"> * Heat or cook food while in cans.
Sausage rolls, pies, Christmas pudding	<ul style="list-style-type: none"> * Cook for the recommended time. (These foods have high sugar and/or fat contents.) 	<ul style="list-style-type: none"> * Overcook as they may catch fire.
Meats	<ul style="list-style-type: none"> * Use a microwave safe rack to collect drained juices. 	<ul style="list-style-type: none"> * Place meat directly on the turntable for cooking.
Utensils	<ul style="list-style-type: none"> * Check the utensils are suitable for MICROWAVE cooking before you use them. 	<ul style="list-style-type: none"> * Use metal utensils for MICROWAVE cooking. Metal reflects microwave energy and may cause an electrical discharge known as arcing.
Aluminium foil	<ul style="list-style-type: none"> * Use to shield food to prevent over cooking. * Watch for sparking. Reduce foil or keep clear of cavity walls. 	<ul style="list-style-type: none"> * Use too much. * Shield food close to cavity walls. Sparking can damage the cavity.
Browning dish	<ul style="list-style-type: none"> * Place a suitable insulator such as a microwave and heat proof dinner plate between the turntable and the browning dish. 	<ul style="list-style-type: none"> * Exceed the preheating time recommended by the manufacturer. Excessive preheating can cause the glass turntable to shatter and/or damage internal parts of the oven.

INSTALLATION INSTRUCTIONS

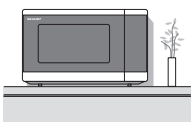
1. Remove all packing materials from the oven cavity, (do not remove the waveguide cover), and the feature sticker from the outside of the door, if there is one. Check the unit for any damage, such as a misaligned door, damaged door seals around the door or dents inside the oven cavity or on the door. If there is any damage, please do not operate the oven until it has been checked by a SERVICE CENTRE APPROVED BY SHARP and repaired, if necessary.
2. Accessories provided
1) Turntable 2) Roller stay 3) High and Low racks 4) Grill tray 5) Combined operation manual and cookbook
3. Since the door may become hot during cooking, you should place or mount the oven so that the bottom of the oven is 85cm or more above floor. You should also keep children away from the door to prevent them burning themselves.
4. This oven can be installed in the locations indicated by the following "checkmarks".

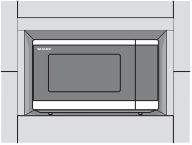
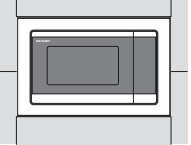
Installation location example	Countertop	On a Shelf	In a Cabinet	Built-In
Installation image diagram				
Presence or absence of check mark	✓	✓	✓	✓
Standard conformity number	(AS/NZS60335)			

This oven is designed to be used on a countertop, on a shelf, in a cabinet or built-in with a Sharp built-in kit EBR-39ST plus EBR-89ST.

It should not be installed in any area where excessive heat and steam are generated, for example, next to a conventional oven unit. The oven should be installed so as not to block ventilation openings. When the oven is mounted on a kitchen countertop, on a shelf or in a cabinet, allow a space of at least 40cm on the top, 5cm on both sides and 5cm at the rear of the oven for adequate air circulation. Additionally, when installing on a shelf or in a cabinet, the minimum dimension of the shelf or cabinet should be 620mm(W)×715mm(H)×560mm(D).

This oven must be operated with cabinet door open. When building the oven into a cabinet or wall, a Sharp built-in kit model number EBR-39ST plus EBR-89ST is available which enable the microwave oven to be integrated within a kitchen. Please check with your retailer for availability.

Read carefully the installation instructions for the built-in kit before installation.

Do not build-in the oven under the countertop or any other appliances.

These built-in kits have been tested according to Australian/New Zealand Standards AS/NZS60335.

Sharp does not recommend the use of any other built-in kit.

WARNING: The electrical outlet must be readily accessible so that the unit can be unplugged easily in an emergency.

5. Neither the manufacturer nor the distributors can accept any liability for damage to the machine or personal injury for failure to observe the correct electrical connecting procedure.
The A.C. voltage must be single phase 230-240V, 50Hz.
6. This appliance must be earthed.
7. Operate the oven from a general purpose domestic outlet. If a generator is used, do not operate the oven with non-sinusoidal outputs.
8. Before using the grill for the first time, operate the oven without food for 20 minutes. This will allow the oil that is used for rust protection to be burned off.

OVEN DIAGRAM

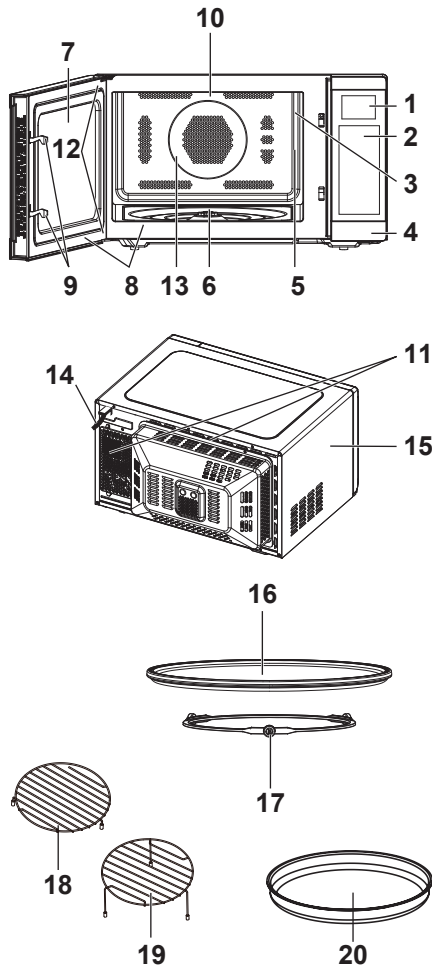

OVEN:

1. LED Display
2. Control panel
3. Oven lamp
4. Door open button
5. Waveguide cover (Do not remove)
6. Coupling
7. See through door
8. Door seals and sealing surfaces
9. Door safety latches
10. Top grill heating element
11. Ventilation openings
12. Door hinges
13. Oven cavity
14. Power supply cord
15. Outer cabinet

ACCESSORIES:

16. Turntable
 17. Roller stay
 18. Low rack
 19. High rack
 20. Grill tray
- Place the roller stay in the centre of the oven floor, then place the turntable on to the roller stay, ensuring it is located firmly into the coupling.
 - To avoid turntable damage, ensure dishes or containers are lifted clear of the turntable rim when removing them from the oven.
 - The racks and grill tray are for Grill, Combi, Convection, AirFry and recommended automatic operations.

Never touch the grill when it is hot.

NOTES:

- The waveguide cover is fragile. Care should be taken when cleaning inside the oven to ensure that it is not damaged.
- After cooking fatty foods without a cover, always clean the cavity and especially the grill heating elements thoroughly, these must be dry and free from grease. Built-up grease may overheat and begin to smoke or catch fire.
- Always operate the oven with the turntable fitted correctly. This promotes thorough, even cooking. A badly fitted turntable may rattle, may not rotate properly and could cause damage to the oven.
- The turntable rotates clockwise or anti-clockwise. The rotary direction may change each time you start the oven. This does not affect cooking performance.

Warning:

The accessories will become very hot whenever the the grill or convection symbols are lit on the display. Use thick oven mittens when inserting/removing the food or turntable from the oven to prevent burns.

OPERATION OF TOUCH CONTROL PANEL

The operation of the oven is controlled by pressing the appropriate pads arranged on the surface of the control panel. An entry signal tone should be heard each time you press the control panel to make a correct entry. In addition the oven will beep 5 times at the end of the cooking cycle, or 4 times when a cooking procedure is required.

Control Panel Display

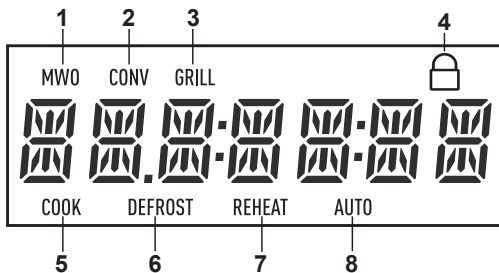

1. **MICROWAVE SYMBOL**
It will appear when setting a programme using the microwave mode, or when in a microwave cooking mode.
2. **CONVECTION SYMBOL**
It will appear when setting a programme using the convection mode, or when in a convection cooking mode.
3. **GRILL SYMBOL**
It will appear when setting a programme using the grill mode, or when in a grill cooking mode.
4. **CHILD LOCK SYMBOL**
It will appear when using child lock.
5. **COOK indicator**
It will light up when the oven is operating.
6. **DEFROST SYMBOL**
It will appear when setting a programme using the defrost mode, or when in a defrost cooking mode.
7. **REHEAT SYMBOL**
It will appear when setting a programme using the reheat mode, or when in a reheat cooking mode.
8. **AUTO SYMBOL**
It will appear when setting a programme using the auto menu mode, or when in a auto cooking mode.

Touch Control Panel Layout

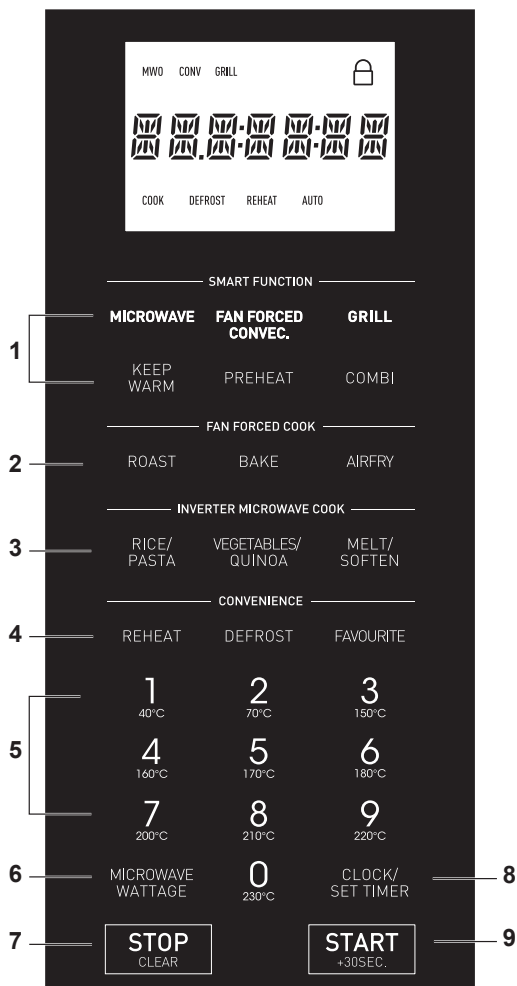

1. **SMART FUNCTION pads**
Press to select cooking mode option.
2. **FAN FORCED COOK pads**
Press to select 3 popular convection menus.
3. **INVERTER MICROWAVE COOK pads**
Press to select 6 popular menus.
4. **CONVENIENCE pads**
Press to select Reheat, Defrost or Favourite.
5. **NUMBER AND TEMPERATURE pads**
Press to enter cooking times, clock time, convection temperature, weight or quantity of food.
6. **MICROWAVE WATTAGE pad**
Press to select microwave power setting. If not pressed, 1100W is automatically selected.
7. **STOP/CLEAR pad**
Press to clear during programming. Press once to stop operation of oven during cooking; press twice to cancel cooking programme.
8. **CLOCK/SET TIMER pad**
Press to set clock time or timer.
9. **START/+30SEC. pad**
Press once to cook for 30 seconds at 1100W or increase by 30 second multiples each time this pad is pressed during manual cooking.
Press to start oven after setting programmes.

BEFORE OPERATING

Getting Started

Step	Procedure	Pad Order	Display
1	Plug the oven into a power point and switch on the power. Ensure the oven door is closed.		MICRO- WAVE OVEN
2	Press the STOP/CLEAR pad.	STOP CLEAR	0

Clock Setting

* To enter the present time of day 11:34 (AM or PM).

Step	Procedure	Pad Order	Display
1	Press the CLOCK/SET TIMER pad once.	CLOCK/ SET TIMER x 1	SET CLOCK PRESS START
2	Press the START/+30SEC. pad.	START +30SEC.	ENTER TIME PRESS START TO SET
3	Enter the correct time of day by pressing the numbers in sequence.	1 1 3 4	11:34
4	Press the START/+30SEC. pad.	START +30SEC.	11:34 The dots (:) will flash on and off.

This is a 12 hour clock. If you attempt to enter an incorrect clock time (e.g. 13:45), ENTER TIME PRESS START TO SET will appear on the display. Re-enter the time of day (e.g. 1:45).

Set Timer







Use this feature as a general purpose timer.

Examples include:

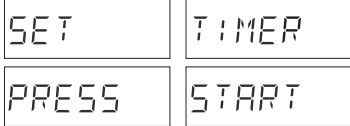
- timing boiled eggs cooked on the stove top.
- timing the recommended standing time of food.

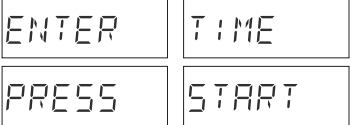
You can enter any time up to 99 minutes, 99 seconds. If you want to cancel the timer during the count down phase simply press STOP/CLEAR.

* Suppose you want to set the timer for 3 minutes to boil an egg on the stove top.

Step	Procedure	Pad Order	Display
1	Press the CLOCK/SET TIMER pad twice.	 × 2	
2			
3	Enter desired time.		
4	Press the START/+30SEC. pad.		 The timer begins to count down. When the timer reaches zero, the oven will “beep”.

Stop/Clear

Press the STOP/CLEAR pad once to:

1. Stop the oven temporarily during cooking.
2. Clear if you make a mistake during programming.
3. Clear the message on the display after cooking.

To Cancel a Programme During Cooking

Press the STOP/CLEAR pad twice.

MANUAL OPERATIONS

<Microwave Cooking>

Microwave Time Cooking

This is a manual cooking feature, first enter the power level then the cooking time.

There are eleven different power levels. You can programme up to 99 minutes, 99 seconds.

This variable cooking control allows you to select the rate of microwave cooking.

After cooking, the fan will continue to operate. NOW COOLING may be displayed when the door is opened or STOP/ CLEAR pad is pressed while the fan is operating.

Display	Power level		Examples
1100	100%	High	Raw meat, Vegetables, Rice or Pasta
990	90%		
880	80%		
770	70%	Medium High	Delicate Food such as Eggs or Seafood.
660	60%		
550	50%	Medium	
440	40%		
330	30%	Medium Low	Defrost, Softening butter
220	20%		
100	10%	Low	Keep food warm
0	0%		

If a wattage level is not selected, then 1100W is automatically used.

* Suppose you want to cook for 10 minutes at 1100W.

Step	Procedure	Pad Order	Display
1	Enter desired cooking time.		
2	Press the START/+30SEC. pad.		 The timer begins to count down.

MANUAL OPERATIONS

<Microwave Cooking>

Microwave Time Cooking

To lower the wattage level press the MICROWAVE WATTAGE pad first. Note the display will indicate “1100W PRESS AGAIN TO LOWER POWER OR PUSH START”. Press the MICROWAVE WATTAGE pad again until required wattage level is displayed.

* Suppose you want to cook Fish Fillets for 10 minutes at 550W.

Step	Procedure	Pad Order	Display
1	Select power level by pressing the MICROWAVE WATTAGE pad as required (for 550W microwave wattage press six times).	MICROWAVE WATTAGE x 6	
2	Press the START/+30SEC. pad.	START +30SEC.	
3	Enter desired cooking time.	1 0 0 0	
4	Press the START/+30SEC. pad.	START +30SEC.	 The timer begins to count down.

If the door is opened during the cooking process, the cooking time in the display automatically stops. The cooking time starts to count down again when the door is closed and the START/+30SEC. pad is pressed.

HELPFUL HINTS:

If you want to check the microwave wattage during cooking, press the MICROWAVE WATTAGE pad. As long as your finger is pressing the MICROWAVE WATTAGE pad, the microwave wattage will be displayed.

Instant Cook

For your convenience Sharp's Instant Cook allows you to easily cook for 30 seconds at 1100W. The Instant Cook function has 2 operation methods (see below).

Each time the START/+30SEC pad is pressed, the cooking time is increased by 30 seconds up to a maximum time of 99 minutes.



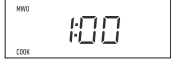

<Not during cooking>

* Suppose you want to cook for 1 minute at 1100W.

Step	Procedure	Pad Order	Display
1	Press the START/+30SEC. pad. Within 3 minutes of closing the door, cooking completion or pressing the STOP/CLEAR pad.	 × 2	 The timer begins to count down.

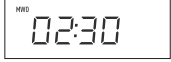

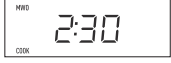
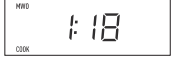

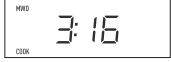
<During cooking in Manual Operation>

* Suppose you want to cook for 2 minutes 30 seconds at 1100W and add 2 minutes during cooking.

Step	Procedure	Pad Order	Display
1	Enter desired cooking time.		
2	Press the START/+30SEC. pad.		 The timer begins to count down.
			
3	Press the START/+30SEC. pad 4 times.	 × 4	

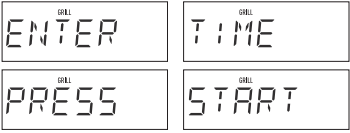
<Heating without Food>

Before the first use and after cleaning the grill must be conditioned. The procedure involves heating the grill for a period of 20 minutes. You may notice some smoke and odour during this process, this is normal, the oven is not out of order. Follow the procedure below.

Step	Procedure	Pad Order	Display
1	Ensure that no food is in the oven. Press the GRILL pad.		
2	Enter the heating time (20 min.).		
3	Press the START/+30SEC. pad. IMPORTANT: During this operation, some smoke and odour will occur. Therefore open the windows or run the ventilation fan in the room.		 The timer begins to count down to zero. When timer reaches zero, all indicators will go out and the oven will “beep”. FINISH REMOVE FOOD will be displayed
4	Open the door to cool the oven cavity. The cooling fan will remain on until the oven cavity has cooled.		

WARNING:

The oven door, outer cabinet, turntable and oven cavity will be hot to PREVENT BURNS allow the oven to cool.

<Convection Cooking>

Please consult your Convection Microwave Cookbook for more specific cooking instructions and procedures.

To Cook by Convection

Your Convection Microwave Oven can be programmed for ten different convection cooking temperatures (230, 220, 210, 200, 180, 170, 160, 150, 70, 40°C) up to 99 minutes, 99 seconds.

* Suppose you want to cook for 20 minutes at 180 °C.

Step	Procedure	Pad Order	Display
1	Place turntable in the oven. Press the FAN FORCED CONVEC. pad.	FAN FORCED CONVEC.	
2	Enter desired temperature.	6 180°C	
3	Press the START/+30SEC. pad.	START +30SEC.	
4	Enter desired cooking time.	2 0 0 0	
5	Press the START/+30SEC. pad.	START +30SEC.	<p>The timer begins to count down to zero. When the timer reaches zero, all indicators will go out and the oven will “beep”. FINISH REMOVE FOOD will be displayed. The cooling fan will remain on and NOW COOLING may be displayed until the oven cavity has cooled.</p>









WARNING:

The oven cavity, door, turntable, racks, grill tray, dishes and especially the grill will become very hot, use thick oven mittens when inserting/removing the food or turntable from the oven to prevent burns.

NOTE: During preheating and convection cooking, you will hear the cooling fan cycling on and off. This is completely normal and will not affect the cooking.

To Preheat and Cook by Convection

* Suppose you want to preheat the oven to 200 °C then cook for 20 minutes at 200 °C.

Step	Procedure	Pad Order	Display	
1	Press the PREHEAT pad.			PREHEAT
2	Press desired preheat temperature pad.			
3	Press the START/+30SEC. pad.		**After preheat is over, unit beeps and displays the following message** PLACE FOOD ENTER COOK TIME PRESS START	COOKING
4	Enter desired cooking time.			
5	Press the START/+30SEC. pad.		 The timer begins to count down to zero and all indicators will go off and the oven will “beep” and FINISH REMOVE FOOD will be displayed. The cooling fan will remain on and NOW COOLING may be displayed until the oven cavity has cooled.	

WARNING:



The oven cavity, door, turntable, racks, grill tray, dishes and especially the grill will become very hot, use thick oven mittens when inserting/removing the food or turntable from the oven to prevent burns.

NOTE: During preheating and convection cooking, you will hear the cooling fan cycling on and off. This is completely normal and will not affect the cooking.

Convection and Microwave Cooking

Your oven can be programmed to combine convection and microwave cooking operations.

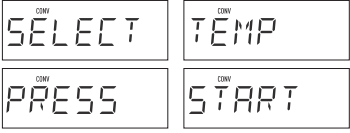
* Suppose you want to roast chicken pieces for 15 minutes at 180 °C and then cook for 8 minutes at 550W.

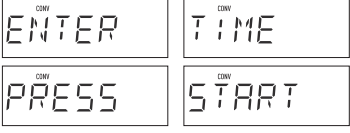
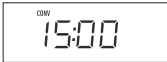
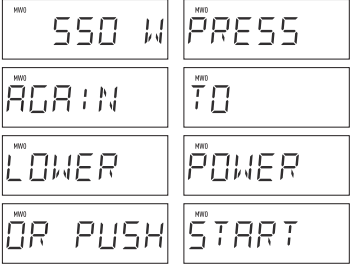
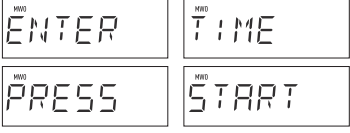
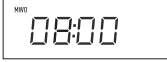
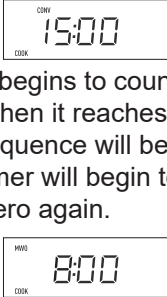
Step	Procedure	Pad Order	Display
1	Press the FAN FORCED CONVEC. pad.	FAN FORCED CONVEC.	
2	Enter desired convection temperature.	6 180°C	
3	Press the START/+30SEC. pad.	START +30SEC.	
4	Enter desired convection cooking time.	1 5 0 0	
5	Select microwave cooking and microwave wattage by pressing the MICROWAVE WATTAGE pad as required (for 550W power press 6 times.)	MICROWAVE WATTAGE × 6	
6	Press the START/+30SEC. pad.	START +30SEC.	
7	Enter desired microwave cooking time.	8 0 0	
8	Press the START/+30SEC. pad.	START +30SEC.	 <p>The timer begins to count down to zero. When it reaches zero, the second sequence will be displayed and the timer will begin to count down to zero again.</p> <p>The timer begins to count down to zero and all indicators will go off and the oven will “beep”.</p>

Do not use plastic (non-heat proof) cookware if combining Convection and Microwave modes.

WARNING:

The oven cavity, door, turntable, racks, grill tray, dishes and especially the grill will become very hot, use thick oven mittens when inserting/removing the food or turntable from the oven to prevent burns.

NOTE: During Preheating and Convection cooking, you will hear the cooling fan cycling on and off. This is completely normal and will not affect the cooking.

<COMBI Cooking>











The Smart COMBI Cooking feature enables a combination of cooking modes to be used alternately. Combination cooking reduces cook time and provides a crisp, brown finish to foods.

To use the Smart COMBI feature press the COMBI pad until the desired programme is displayed.

It is not necessary to preheat for combination cooking.

COMBI	C-1	C-2	C-3	C-4
	Microwave + Convection	Microwave + Grill	Grill + Convection	Microwave + Grill + Convection
Microwave	●	●		●
Grill		●	●	●
Fan-Forced Convection	●		●	●

* Suppose you want to cook for 6 minutes with Microwave and Grill.

Step	Procedure	Pad Order	Display
1	Press the COMBI pad twice.	 x 2	 
2	Press the START/+30SEC. pad.		 
3	Enter desired cooking time.		
4	Press the START/+30SEC. pad.		 The timer begins to count down to zero and all indicators will go off and the oven will “beep” and FINISH REMOVE FOOD will be displayed. The cooling fan will remain on and NOW COOLING may be displayed until the oven cavity has cooled.













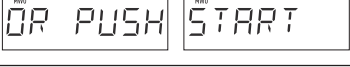

WARNING:

The oven cavity, door, turntable, racks, grill tray, dishes and especially the grill will become very hot, use thick oven mittens when inserting/removing the food or turntable from the oven to prevent burns.

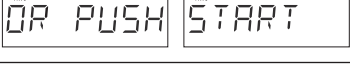
<Multiple Sequence Cooking>



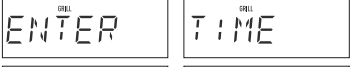
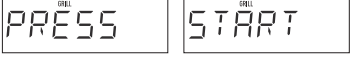

Preheating, Microwave Cooking, Convection Cooking, Grill Cooking and COMBI Cooking can be programmed to up to 4 manual cooking sequences, switching from one variable power setting to another. Note that MICROWAVE WATTAGE must be entered first when programming sequence cooking.

* Suppose you want to cook for 10 minutes at 880W microwave power, cook for 5 minutes at 1100W and cook with Grill for 20 minutes.

Step	Procedure	Pad Order	Display
1	Select microwave cooking and desired wattage level by pressing the MICROWAVE WATTAGE pad (for 880W microwave power press three times).	MICROWAVE WATTAGE × 3	   
2	Press the START/+30SEC. pad.	START +30SEC.	 
3	Enter desired cooking time.	1 0 0 0	
4	For second sequence, select microwave cooking and wattage level (for 1100W press the MICROWAVE WATTAGE pad once)	MICROWAVE WATTAGE × 1	   
5	Press the START/+30SEC. pad.	START +30SEC.	 
6	Enter desired cooking time for the second sequence.	5 0 0	
7	For third sequence, press the GRILL pad.	GRILL	 
8	Enter desired cooking time.	2 0 0 0	

Continued on next page.

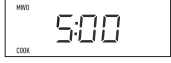
<Multiple Sequence Cooking - cont'd>

Step	Procedure	Pad Order	Display
9	Press the START/+30SEC. pad.		 <p>The timer begins to count down to zero. When it reaches zero,</p>  <p>the second sequence will be displayed and the timer will begin counting down to zero again.</p>  <p>And then the third sequence will be displayed and the timer will begin counting down to zero. All indicators will go off and the oven will “beep” and FINISH REMOVE FOOD will be displayed. The cooling fan will remain on and NOW COOLING may be displayed until the oven cavity has cooled.</p>

WARNING:

The oven cavity, door, turntable, racks, grill tray, dishes and especially grill will become very hot, use thick oven mittens when inserting/removing the food or turntable from the oven to prevent burns.

<AUTOMATIC MENUS>







INVERTER MICROWAVE COOK

RICE/
PASTA VEGETABLES/
QUINOA MELT/
SOFTEN

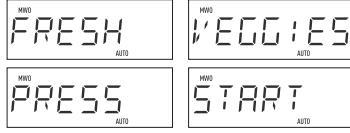
- | | | |
|---------------------|----------------------------|----------------------|
| RICE / PASTA | VEGETABLES / QUINOA | MELT / SOFTEN |
| 1.White Rice | 1.Fresh Vegetables | 1.Chocolate |
| 2.Brown Rice | 2.Frozen Vegetables | 2.Butter |
| 3.Pasta | 3.Sweet Jacket Potato | 3.Cream Cheese |
| 4.Wholemeal Pasta | 4.Quinoa | |

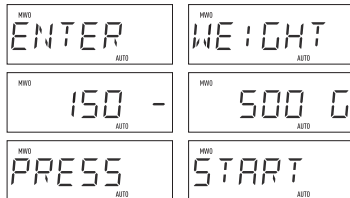
Press pads until the desired menu appears on the display.
Follow the details provided in the INVERTER MICROWAVE COOK MENU GUIDE on page ⑧- ⑨ in the cooking guides.

* Suppose you want to cook 150g Fresh Vegetables.

Step	Procedure	Pad Order	Display
1	Press the VEGETABLES/QUINOA pad .	 × 1	
2	Press the START/+30SEC. pad.		
3	Enter the weight.		
4	Press the START/+30SEC. pad.		 The timer begins to count down. The oven will “beep” 5 times and will stop. FINISH REMOVE FOOD will be displayed repeatedly.

Fan Forced Cook (ROAST/BAKE)

ROAST BAKE

ROAST

1. Roast Chicken
2. Roast Beef
3. Roast Lamb
4. Roast Pork









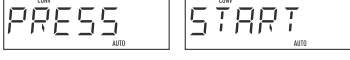

BAKE

1. Butter Cake
2. Lasagne (400g)

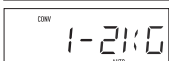
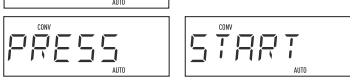
Press pads until the desired menu appears on the display.

Follow the details provided in the FAN FORCED COOK MENU GUIDE on page 6 in the cooking guides.

* Suppose you want to cook 1.0 kg Roast Beef (Medium).

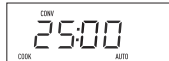
Step	Procedure	Pad Order	Display
1	Press the ROAST pad.	 × 2	 
2	Press the START/+30SEC. pad.		  
3	Enter the weight.		
4	Press the START/+30SEC. pad.		 The timer begins to count down. The oven will “beep” 4 times and will stop. TURN OVER BEEF PRESS START will be displayed repeatedly.
5	Open the door. Turn over the meat. Close the door.		TURN OVER BEEF PRESS START will be displayed repeatedly.
6	Press the START/+30SEC. pad.		 When the cooking time reaches zero, FINISH REMOVE FOOD will be displayed repeatedly.







Fan Forced Cook (AIRFRY)

AIRFRY

- AIRFRY**
- 1. Frozen French Fries
 - 4. Frozen Onion Rings
 - 7. Frozen Crumbed Prawns
 - 2. Frozen Potato Gems
 - 5. Frozen Chicken Nuggets
 - 8. Fresh Vegetables
 - 3. Frozen Squid
 - 6. Frozen Schnitzel
 - 9. Frozen Spring Rolls

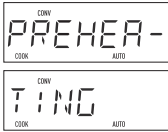
Press pads until the desired menu appears on the display.
 Follow the details provided in the FAN FORCED COOK MENU GUIDE on page 5 in the cooking guides.

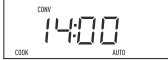
* Suppose you want to cook 230 g Frozen Crumbed Prawns.

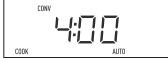
Step	Procedure	Pad Order	Display
1	Press the AIRFRY pad.	 × 7	
2	Press the START/+30SEC. pad.		 The timer begins to count down. The oven will “beep” 2 times and will stop. PLACE FOOD PRESS START will be displayed repeatedly.
3	Open the door. Place the food. Close the door.		PLACE FOOD PRESS START will be displayed repeatedly.
4	Press the START/+30SEC. pad.		 The timer begins to count down. The oven will “beep” 4 times and will stop. TURN OVER FOOD PRESS START will be displayed repeatedly.
5	Open the door. Turn over the food. Close the door.		TURN OVER FOOD PRESS START will be displayed repeatedly.
6	Press the START/+30SEC. pad.		 When the cooking time reaches zero, the oven will “beep” 5 times, FINISH REMOVE FOOD will be displayed repeatedly.

Convenience (REHEAT/DEFROST)







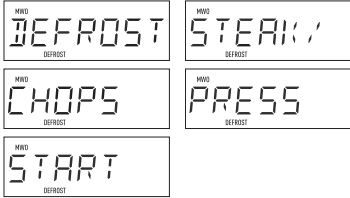

REHEAT DEFROST

REHEAT
1. Plate (400g)
2. Beverage

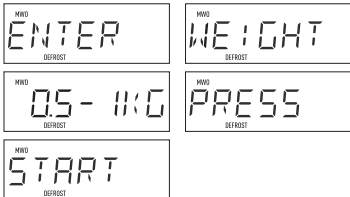
DEFROST
1. Mince
2. Steak/Chops
3. Roast Meat
4. Whole Chicken
5. Chicken Fillet
6. Fish Fillet

Press to select popular reheat and defrost menus.
Follow the details provided in the CONVENIENCE MENU GUIDE on page ⑦ in the cooking guides.

* Suppose you want to defrost 0.5 kg steak.

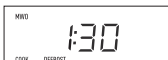
Step	Procedure	Pad Order	Display
1	Press the DEFROST pad.	 × 2	
2	Press the START/+30SEC. pad.		
3	Enter the weight.		
4	Press the START/+30SEC. pad.		 The timer begins to count down. The oven will “beep” 4 times and will stop. TURN OVER STEAK/CHOPS PRESS START will be displayed repeatedly.
5	Open the door. Turn over the meat. Close the door.		TURN OVER STEAK/CHOPS PRESS START will be displayed repeatedly.
6	Press the START/+30SEC. pad.		 When the cooking time reaches zero, FINISH REMOVE FOOD will be displayed repeatedly.

Convenience (FAVOURITE)

FAVOURITE

The favourite function allows you to store 3 frequently used microwave power levels and cook times to make cooking/reheating more convenient.

- * Suppose you want to set the following procedure as Favourite 2.
Cook food for 3 minutes and 20 seconds at 880W.

Step	Procedure	Pad Order	Display
1	Press the FAVOURITE pad twice.	FAVOURITE × 2	2 PRESS OR MICRO KEY TO START PRESS WATTAGE PROGRAM



If the procedure has been set, press START/+30SEC. to use it. If not, continue to set the procedure.
Only one or two stages can be set.

Step	Procedure	Pad Order	Display
2	Select desired power level by pressing the MICROWAVE WATTAGE pad.	MICROWAVE WATTAGE × 3	880 W PRESS AGAIN TO LOWER POWER OR PUSH START
3	Press the START/+30SEC. pad.	START +30SEC.	ENTER TIME PRESS START
4	Enter desired cooking time.	3 2 0	3:20
5	Press the START/+30SEC. pad.	START +30SEC.	ENTER 2ND MICRO WATTAGE OR PUSH START TO END
6	Press the START/+30SEC. pad to save as FAVOURITE 2 and to operate. To add another stage to the program repeat steps 2 to 5.	START +30SEC.	

Child Lock

If the oven is accidentally started with no food or liquid in the cavity, the life of the oven can be reduced. To prevent accidents like this, your oven has a “Child Lock” feature that you can set when the oven is not in use.

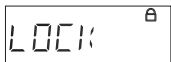

* To set the Child Lock.

Step	Procedure	Pad Order	Display
1	Press the number 0 pad for 3 seconds.		
2	Press the START/+30SEC. pad.		

If set the time of day, the time of day will be displayed.

The control panel is now locked, each time a pad is pressed, the display will show “LOCK”.

* To cancel the Child Lock.



Step	Procedure	Pad Order	Display
1	Press the STOP/CLEAR pad for 3 seconds.		 The oven is ready to use.

Mute/Unmute



If you don't want to be disturbed by the beep sound during operation or cooking, please use the Mute function to make the oven work quietly.

The oven can be muted only in standby state.

* To set the Mute mode.

Step	Procedure	Pad Order	Display
1	Press the MICROWAVE pad for 5 seconds.		

* To cancel the Mute mode.

Step	Procedure	Pad Order	Display
1	Press the MICROWAVE pad for 5 seconds.		

NOTE: Even if the Mute is activated, beep sounds in the following situations:

1. When error happens.
2. When the STOP pad is pressed during heating.
3. When the Mute is canceled.

CARE AND CLEANING

Disconnect the power supply cord before cleaning or leave the door open to inactivate the oven. Before cleaning ensure oven cavity is cool.

OVEN INTERIOR:

- It is important to clean the interior of your microwave oven after each use.
- To clean the oven interior, use a mild detergent solution, such as washing-up liquid, with warm water on a soft cloth.
- Heat up your oven regularly by using the grill. Remaining food or splatters can cause smoke or odours.
- Food and liquid splashes will build-up on the oven walls and ceiling. If grease, fat and food debris is allowed to build-up on the oven interior it may overheat, smoke or even catch fire when next using the oven.
- Keep the waveguide cover clean at all times. The waveguide cover is constructed from a fragile material and should be cleaned with care (follow the cleaning instructions above).
- Food will release steam during cooking and cause condensation inside the oven and door. It is important to wipe the oven dry. A build-up of condensation will eventually lead to rust forming on the oven interior.
- Do not allow grease or dirt to build-up on the door seals or areas around the door. This may prevent the door from closing correctly and may cause a leakage of microwaves (follow the cleaning instructions below).
- Ensure the accessories are cleaned after every use with a mild washing-up liquid solution and dried. This will prevent the build-up of grease and food debris.
- Clean the oven at regular intervals and remove any food deposits. Failure to maintain the oven in a clean condition could lead to a deterioration of the surface that could adversely affect the life of the appliance and possibly result in a hazardous situation.

OUTER CABINET:

- Wipe the outside of the microwave oven with a mild detergent solution, such as washing-up liquid, with warm water on a soft cloth.
- The control panel must be wiped clean and dried with the door open, therefore inactivating the oven.

DOOR:

- To remove all traces of dirt, regularly clean both sides of the door, the door seals and adjacent parts with a soft, damp cloth.
- Do not use harsh abrasive cleaners or sharp metal scrapers to clean the oven door glass since they can scratch the surface, which may result in shattering of the glass.

NOTES:

- Never use spray cleaners, oven pads or abrasive scourers as these damage the surface of the oven.
- A steam cleaner should not be used.
- Take care not to let soapy water drip through the small holes in the oven walls and the cavity floor. Excess water spillage through these holes will cause damage to the oven interior.
- Slight tarnishing of the oven cavity, around the area of the grills, is likely to occur. This is normal and will not affect the ovens performance.

WARNING:

Before cleaning, make sure the oven cavity, door, oven cabinet, accessories and especially the grills are completely cool.

TROUBLE SHOOTING

IN CASE OF THE FOLLOWING DISPLAY;

E-05:	The oven stopped cooking because the internal temperature is very hot. Press the STOP/CLEAR pad to clear the error code and open the door to let the oven cool. You can manually restart cooking after the oven has cooled down. If the display continues to show the error code or you cannot restart cooking, follow the SERVICE CALL CHECK procedures provided in the next page.
Other than E-05:	Your oven may require servicing. Follow the SERVICE CALL CHECK procedures provided in the next page.

SERVICE CALL CHECK

Check the following before calling for a service:

1. Does the display light? Yes _____ No _____
2. When the door is opened, does the oven lamp come on? Yes _____ No _____
3. Place one cup of water (approx. 250 ml) in a glass measure in the oven and close the door securely. Press the START/+30SEC. pad twice.
 - A. Does the oven lamp light? Yes _____ No _____
 - B. Does the cooling fan work? Yes _____ No _____
(Put your hand over the rear ventilation openings.)
 - C. Does the turntable rotate? Yes _____ No _____
(The turntable can rotate clockwise or counterclockwise. This is quite normal.)
 - D. Does the COOK indicator light? Yes _____ No _____
 - E. After one minute, did an audible signal sound? Yes _____ No _____
 - F. Is the water inside the oven hot? Yes _____ No _____
4. Remove water from the oven and programme the oven for 3 minutes on GRILL mode.
 - A. Does the GRILL symbol and cook indicator light? Yes _____ No _____
 - B. After 3 minutes, does the grill become red? Yes _____ No _____

If "NO" is the answer to any of the above questions, please check your wall socket and the fuse in your meter box. If both the wall socket and the fuse are functioning properly, CONTACT YOUR NEAREST SERVICE CENTRE APPROVED BY SHARP.

NOTE: Microwave power in microwave cooking mode will be optimized the power level automatically to prevent overheating.

However, when cooking is made continuously, the safety function of the microwave oven may automatically activate and reduce the microwave oven power level of above optimized level.

If the inside of the microwave oven or accessories such as tray, dish, cup, etc. are hot, microwave cooking may not be completed properly. If the food is not heated sufficiently, please re-heat while watching the cooking condition.

SPECIFICATIONS

AC Line Voltage	Single phase 230–240V, 50Hz
AC Power Required (Steady)	
Microwave (Steady)	1300 W
Microwave (Initial)	1800 W
Grill	1130 W
Convection	2150 W
Output Power	
Microwave	1100 W* (IEC test procedure)
Grill	1100 W
Convection	2100 W
Microwave Frequency	2450 MHz (Class B/Group 2)**
Outside Dimensions (W × H × D)	520 × 315 × 480mm
Cavity Dimensions (W × H × D)	351 × 258 × 351mm
Overall Cavity Volume	32L
Weight	Approx. 15.3 kg

* When tested in accordance with AS/NZS 2895.1.2007

** This is the classification of ISM (Industrial, Scientific and Medical) equipment described in the International Standard CISPR11. In conformity with this standard, this product is classified as group 2 class B equipment. Group 2 means that the equipment intentionally generates radio-frequency energy in the form of electromagnetic radiation for heating treatment of food. Class B equipment means that the equipment suitable to be used in domestic establishments.

ROAST MEAT AND POULTRY CHART

1. Use the low rack.
2. Preheat oven according to the temperature in the PREHEAT TEMPERATURE column.
3. Season meat/poultry if desired and cover lightly with oil.
4. Turn meat/poultry over half way through cooking.

MEAT	COOKING TIME	PREHEAT TEMPERATURE	COOKING TEMPERATURE	STANDING TIME
Beef Roast	25-27 minutes/500g	200°C	200°C	15-25 minutes
Lamb Roast	25-27 minutes/500g	200°C	200°C	15-25 minutes
Pork Roast	30-32 minutes/500g	230°C	230°C	10-20 minutes
Roast Chicken	20-22 minutes/500g	220°C	220°C	5-10 minutes

*Maximum 2kg weight per roast.

** Times are an estimation only. You may have to adjust times and temperatures according to your preference.

FAN-FORCED CONVECTION CHART

FOOD	AMOUNT	COOKING FUNCTION	COOKING TIME	PROCEDURE
Cake	850g	Convection 180°C	55 minutes	Preheat to 180°C. Bake cake in cake tin on the low rack.
Thin Chips	200g	Convection 230°C	35 minutes	Preheat to 230 °C. Use a baking tray. Place chips in a single layer. Turn over half way through cooking.
Thick Chips	200g	Convection 230°C	35 minutes	Preheat to 230 °C. Use a baking tray. Place chips in a single layer. Turn over half way through cooking.
Chicken Chips	250g	Convection 230°C	15 minutes	Preheat to 230 °C. Use a baking tray. Place chips in a single layer. Turn over half way through cooking.
Chicken Nuggets	12 nuggets	Convection 230°C	20 minutes	Preheat to 230 °C. Use a baking tray. Place nuggets in a single layer. Turn over half way through cooking.
Potato Wedges	250g	Convection 230°C	30 minutes	Preheat to 230 °C. Use a baking tray. Place wedges in a single layer. Turn over half way through cooking.
Roast Vegetables e.g. Potato, Sweet Potato, Pumpkin	500g	Convection 200°C	55 minutes	Preheat to 200 °C. Use a baking tray. Place vegetables in a single layer. Spray lightly with cooking oil and season to taste. Turn over half way through cooking.
Mini Pies	10 mini pies	Convection 220°C	25 minutes	Preheat to 220 °C. Use a baking tray. Place pies in a single layer. Turn over half way through cooking.
Mini Sausage Rolls	10 mini sausage rolls	Convection 220°C	25 minutes	Preheat to 220 °C. Use a baking tray. Place sausage rolls in a single layer. Turn over half way through cooking.
Frozen Lasagne	400g	Convection 200°C	50 minutes	Preheat to 200 °C. Use an oven safe dish. Do not cover.

REHEATING CONVENIENCE – FOOD CHART DEFROSTING CONVENIENCE

FOOD	AMOUNT	COOKING TIME AND POWER LEVEL	PROCEDURE	STANDING TIME
Beverage (room temp.) 250mL per cup	1 cup 2 cups	2 minutes – 2 minutes 30 seconds on 880W 3-4 minutes on 880W	Stir after heating.	
Canned Food (room temp.) (e.g. Spaghetti, Baked Beans)	1 cup 2 cups	3-5 minutes on 550W 6-8 minutes on 550W	Place food in bowl. Cover with plastic wrap and pierce 5 times with a skewer. Stir halfway.	2 minutes
Canned Soup (room temp) 250mL per cup (thin soup)	1 cup 2 cups	3-4 minutes on 1100W 5-6 minutes on 1100W	Place food in bowl. Cover with plastic wrap or lid. Stir halfway.	2 minutes
Meat Pie (refrigerated) Individual 180g each	1 pie 4 pies	5-6 minutes on 550W 10-11 minutes on 550W	Place directly on turntable, face side down. Cover with paper towel. Turn over halfway.	2 minutes
Frozen Rice/Pasta Dinners (e.g. Lasange, Risotto)	300-500g	7-9 minutes on 1100W	Remove from foil container. Cover with plastic wrap or lid. Allow to stand	2 minutes
Pizza Slice (refrigerated) Slice 100g each	1 slice 2 slices	1 minute – 1 minute 30 seconds on 770W 1 minute 30 seconds – 2 minutes on 770W	Place on a sheet of paper towel. Place directly on the turntable.	
Dinner Plate (refrigerated) 350g-400g per serve	1 serve	3-5 minutes on 1100W	Slice potato. Cover plate with plastic wrap and pierce 5 times with a skewer. Place directly on turntable. Allow to stand.	2 minutes
Casserole (refrigerated) 250g per serve	1 serve 2 serves	5-6 minutes on 550W 7-9 minutes on 550W	Place in a bowl, cover with plastic wrap. Place directly on turntable. Stir halfway. Allow to stand, then stir.	2 minutes
Croissants (frozen)	1 2	1 minute on 330W 1 minute 30 seconds on 330W	Place between paper towels. Place directly on the turntable.	
Fruit Pie individual (frozen) 135g each	1 2	2-3 minutes on 330W 3-4 minutes on 330W	Remove from foil container. Place on a plate and then onto the turntable. Allow to stand.	2 minutes
Danish Pastry whole (frozen)	400g	5-6 minutes on 330W	Remove from foil container. Place on dinner plate. Allow to stand.	2 minutes

NOTE: Room Temperature +20°C
 Refrigerator Temperature +3°C
 Frozen Temperature -18°C

FROZEN VEGETABLE CHART

1. Place vegetables in a medium/large microwave safe bowl and cover with plastic wrap.
2. Halfway through cooking, stir the vegetables to ensure even cooking.
3. Allow to stand for 2 minutes before draining any water and serving.

VEGETABLE	AMOUNT	MICROWAVE TIME 1100W	PROCEDURE
Beans (green, cut)	500g	8-10 minutes	
Broccoli	500g	8-10 minutes	Break apart as soon as possible. Arrange with flower towards the centre.
Carrots (sliced)	500g	10-12 minutes	Stir halfway through.
Cauliflower	500g	8-10 minutes	Break apart as soon as possible. Arrange with flower towards the centre.
Corn on the Cob	4 pieces	8-10 minutes	
Peas (green)	500g	7-9 minutes	
Spinach	250g	6-7 minutes	Break apart as soon as possible.
Mixed Vegetables (i.e. carrots, beans and corn kernels)	500g	13-15 minutes	Break apart as soon as possible.

RICE AND PASTA COOKING CHART

1. Wash and strain rice before measuring amounts.
2. Place rice/pasta in a medium/large microwave safe bowl with water. Cook uncovered at 1100W, stirring halfway through cooking. Allow to stand for 2 minutes before straining any remaining water and serving.

FOOD		OTHER INGREDIENTS	MICROWAVE TIME 1100W
Pasta	1 cup	2 cups hot water	15-17 minutes
	2 cups	4 cups hot water	18-20 minutes
	4 cups	6 cups hot water	19-21 minutes
White Rice	1 cup	2 cups hot water	15-17 minutes
	2 cups	4 cups hot water	18-20 minutes
	4 cups	6 cups hot water	25-27 minutes
Brown Rice	1 cup	2 cups hot water	26-28 minutes
	2 cups	4 cups hot water	34-36 minutes
	4 cups	6 cups hot water	49-51 minutes
Quick Oats	1 cup	2 ¼ cups milk	5-6 minutes

GUIDE TO COOKING EGGS

Place butter, eggs and milk in a small/medium microwave safe bowl. Beat with a fork until well combined and yolks of eggs are completely stirred in. Cook uncovered, stirring halfway through cooking.

EGG(S)	BUTTER	MILK	MICROWAVE TIME 770W
1	1 tsp	1 tbsp	1 minute
2	2 tsp	1 tbsp	2 minutes
3	1 tbsp	2 tbsp	3 minutes
4	1 tbsp	¼ cup	4 minutes

FRESH VEGETABLE CHART

1. Wash vegetables under cold running water.
2. Cover required dishes with plastic wrap or a lid.
3. Drain any remaining water after standing before serving.

VEGETABLE	AMOUNT	MICROWAVE TIME 1100W	PROCEDURE
Asparagus	500g	3-5 minutes	Place in a microwave safe dish. Cover. Stand for 2 minutes.
Beans (top and tailed)	500g	5-6 minutes	Place in a microwave safe dish with 1 tablespoon of water. Cover. Stand for 2 minutes.
Broccoli (uniform florets)	500g	4-6 minutes	Place in a microwave safe dish. Cover. Stand for 2 minutes.
Brussels Sprouts	500g	4-6 minutes	Place in a microwave safe dish. Cover. Stand for 2 minutes.
Cabbage (shredded)	500g	6-8 minutes	Place in a microwave safe dish with 2 tablespoons of water. Cover. Stand for 2 minutes.
Carrots (sliced)	500g	5-7 minutes	Place in a microwave safe dish. Cover. Stand for 2 minutes (cook for longer for less crunch).
Cauliflower (uniform florets)	500g	4-6 minutes	Place in a microwave safe dish with 1 tablespoon of water. Cover. Stand for 2 minutes.
Corn on the Cob	2 pieces	6-8 minutes	Rinse corn under cold water. Place corn in husk and place directly on the turntable. Turn over during cooking. Stand for 2 minutes.
Mushrooms (quartered)	500g	4-6 minutes	Place in a microwave safe dish with 1 tablespoon of water. Cover. Stand for 2 minutes.
Potatoes – Jacket	4 medium	12-13 minutes	Pierce with a fork. Turn over during cooking. Stand for 2 minutes.
Potatoes – Boiled	4 medium	14-16 minutes	Peel and quarter potatoes. Cook in a dish with 1/3 cup water. Cover. Stand for 2 minutes.
Pumpkin (2cm cubes)	500g	8-10 minutes	Place in a microwave safe dish. Cover. Stand for 2 minutes.
Spinach (shredded)	500g	3-4 minutes	Place in a microwave safe dish with 2 tablespoons of water. Cover. Stand for 2 minutes.
Snow Peas (top and tailed)	500g	3-5 minutes	Place in a microwave safe dish with 1 tablespoon of water. Cover. Stand for 2 minutes (cook for longer for less crunch).
Sweet Potato (2cm cubes)	500g	6-8 minutes	Place in a microwave safe dish. Cover. Stand for 2 minutes.
Zucchini (sliced)	500g	4-6 minutes	Place in a microwave safe dish with 1 tablespoon of water. Cover. Stand for 2 minutes.

CHARTS

DEFROST TIMES FOR MEAT, POULTRY, BREAD AND PIES

1. Remove wrapping and place frozen item on a shallow, Microwave safe plastic defrost rack. If necessary, shield thin areas with aluminum foil to prevent the item from cooking while defrosting.
2. Defrost by following the steps in the MICROWAVE TIME column.
3. Set the microwave to 330W.
4. When turning over, re-shield any warm areas so it continues to defrost without cooking.

CUT	MICROWAVE TIME	STANDING TIME
BEEF (Roast)	5-7 minutes/500g	10-15 minutes
Steaks	3-5 minutes/500g	10 minutes
Minced Beef	3-5 minutes/500g	10 minutes
PORK (Roast)	5-7 minutes/500g	10-15 minutes
Chops	3-5 minutes/500g	10 minutes
Ribs	5-6 minutes/500g	10 minutes
Minced Pork	5-6 minutes/500g	10 minutes
LAMB (Roast)	5-7 minutes/500g	10-15 minutes
Chops	3-5 minutes/500g	10 minutes
POULTRY		
Chicken (Whole)	7-9 minutes/500g	10-15 minutes
Pieces	6-8 minutes/500g	10 minutes

BREAD / PIES	MICROWAVE TIME	PROCEDURE
2 Slices of Bread	30 seconds	Place between paper towel and place directly on the turntable.
4 Slices of Bread	1 minute – 1 minute 30 seconds	
1 Bread Roll	30 second – 1 minute	
2 Bread Rolls	2 minutes	
Individual Pie	3 minutes	Remove from packaging. Place between paper towel and place directly on the turntable. Turn over halfway. Allow to stand 3-5 minutes before reheating.

APRICOT WHEATGERM CRUNCHIES

Makes 18

125 g butter
¾ cup brown sugar, lightly packed
½ teaspoon vanilla essence
1 egg
½ cup self-raising flour, sifted
¾ cup wheatgerm
⅓ cup desiccated coconut
⅓ cup rolled oats
125 g dried apricots, chopped
1½ cups cornflakes

1. Preheat oven to 200°C.
2. Cream butter and sugar together until light and fluffy. Add vanilla and egg. Beat well.
3. Mix in flour, wheatgerm, coconut, rolled oats, apricots and cornflakes.
4. Shape tablespoonfuls of mixture into balls.
5. Place on a greased pizza tray: flatten slightly with a fork.
6. Place on the low rack. Bake for 12-14 minutes on CONVECTION 200°C.

NOTE: Cook in the two batches.

MUESLI CUSTARD DELIGHT

Serves 6-8

300 g carton, sour cream
3 × 410 g can, sliced peaches, drained
1 cup butter cake mix
2 cups toasted muesli
½ cup coconut
175 g butter, melted

1. Spread sour cream evenly over base of a 20 cm glass pie plate. Sprinkle with drained peaches.
- 2.

CHOCOLATE CHIP COOKIES

Makes 24

125 g butter
½ cup caster sugar
½ cup brown sugar, lightly packed
½ teaspoon vanilla essence
1 egg
1¾ cups self-raising flour, sifted
½ teaspoon salt
125 g choc bits
60 g walnut pieces

CHOCOLATE SELF-SAUCING PUDDING

Serves 4-6

60 g butter
1½ cups self-raising flour
½ cup caster sugar
¼ cup cocoa powder
¾ cup milk
1 teaspoon vanilla essence
1 cup brown sugar
⅓ cup cocoa powder, extra
2 cups boiling water

1. Place butter in a large microwave safe pudding bowl; melt for 40 seconds on 1100W.
2. Stir in flour, sugar, cocoa, milk and vanilla. Beat until smooth.
3. Combine brown sugar and extra cocoa and boiling water. Pour over pudding mixture.
4. Cook for 12 minutes on 1100W. Allow to stand for 5 minutes before serving.
5. Serve hot with ice-cream.

BREAD AND BUTTER PUDDING

Serves 4-6

6 slices multigrain bread, crusts removed
butter
3 tablespoons caster sugar
¼ cup sultanas
2 cups milk
½ teaspoon vanilla essence
3 eggs, lightly beaten
3 tablespoons brown sugar
¼ teaspoon nutmeg

1. Spread bread with butter and cut into 2 cm cubes.
2. Place bread, sugar and sultanas in a 2 litre pudding bowl.
3. Heat milk and vanilla in a small microwave safe bowl for 3 minutes on 1100W. Gradually whisk into eggs, then pour over bread mixture.
4. Sprinkle with brown sugar and nutme.g.
5. Cook for 25-28 minutes on 330W.
6. Allow to stand for 5 minutes before serving.

CARAMEL RICE PUDDING

Serves 4-6

1 cup arborio rice
3 cups water
395 g can condensed milk
20 g butter
1 tablespoon lemon juice
3 eggs, separated
1 tablespoon vanilla essence
2 tablespoons caster sugar
cinnamon sugar

1. Place rice and water in a large microwave safe glass bowl. Cook for 12-15 minutes on 1100W, or until tender. Stir at halfway. Drain.
2. Mix condensed milk and butter together. Cook for 4-6 minutes on 1100W, stirring every 20 seconds. (Caramel will boil over if not stirred.)
3. Stir cooked rice, lemon juice, egg yolks and vanilla essence into caramel. Pour into a 2-litre pudding bowl.
4. Beat egg whites until stiff, gradually beat in sugar. Spoon over rice pudding.
5. Sprinkle with cinnamon sugar. Cook for 3-5 minutes on 550W and 3 minutes on GRILL.
6. Stand 5 minutes before serving.

CHOCOLATE MOUSSE

Serves 4

200 g cooking chocolate
2 tablespoons water
2 tablespoons rum
¼ cup caster sugar
3 egg whites
300 mL carton thickened cream
extra cream for decoration
30 g chocolate, grated

1. Place chocolate, water and rum in a large microwave safe bowl. Melt for 30 seconds-1 minute on 1100W. Stir in sugar.
2. Allow mixture to cool, then whip until aerated.
3. Beat egg whites until stiff peaks form.
4. Whip the cream until thick but not stiff. Fold cream and beaten egg whites into chocolate mixture.
5. Divide mixture evenly between four dessert glasses. Refrigerate until set.
6. Serve decorated with cream and chocolate shavings.

DESSERTS

CALIFORNIAN APPLE CRUNCH

Serves 6-8

800 g can pie apple
1½ cups White Wings buttercake mix
125 g hard butter, cut into thin slices
3 tablespoons brown sugar
3 tablespoons coconut
2 tablespoons crushed nuts
1 teaspoon cinnamon

1. Place pie apple in a shallow casserole dish.
2. Sprinkle evenly with dry cake mix.
3. Layer sliced butter over cake mix, covering completely.
4. Combine last 4 ingredients and sprinkle over sliced butter.
5. Cook for 6 minutes on 1100W and 3½ minutes on GRILL.
6. Serve warm with whipped cream.

AUSTRALIAN FRUIT CAKE

Serves 4-6

1 kg mixed fruit	1 cup plain flour, sifted
1 cup brown sugar	1 teaspoon baking powder
250 g butter, chopped	salt
2 tablespoons brandy	½ teaspoon nutmeg
4 eggs, lightly beaten	1 teaspoon cinnamon
2 teaspoons parisienne essence	2 tablespoons brandy, extra

1. Preheat oven to 180°C.
2. Combine the first 4 ingredients in a large microwave safe bowl. Cover and cook for 5 minutes on 1100W, stirring once. Allow to cool slightly.
3. Stir in eggs and parisienne essence, followed by dry ingredients.
4. Pour into a greased 20cm square cake tin.
5. Cook for 55 minutes on CONVECTION 180°C.
6. Using a 3 cm foil strip, place around the outside of cake container at halfway of cooking time. (This will prevent the outside from overcooking before the centre is cooked.)
7. Stand covered for 15 minutes before turning out.
8. Pour over extra brandy. Decorate with extra glacé fruits if desired.

BAKED APPLES

Serves 4

¾ cup walnuts	4 large apples
¼ cup brown sugar	2 tablespoons lemon juice
2 teaspoons mixed spice	30 g butter, melted

1. Place walnuts, sugar and mixed spice in a blender or food processor, process until nuts are finely chopped.
2. Peel and core apples, brush with lemon juice.
3. Brush apples with butter. Toss in walnut mixture until evenly coated.
4. Place in base of a 20 cm glass pie plate. Fill centre of apples with any remaining walnut mixture.
5. Cook for 4-6 minutes on 1100W and 6-8 minutes on GRILL. Allow to stand for 5 minutes.
6. Serve with whipped cream.

CHOCOLATE CAKE

175 g Nestlé Milk Choc Melts	2 eggs, lightly beaten
100 g butter	2½ cups self-raising flour, sifted
125 mL (½ cup) sour cream	1 cup brown sugar
1¼ cups warm water	½ teaspoon baking powder

ICING

250 g chocolate
2 tablespoons black coffee
50 mL sour cream

1. Place chocolate and butter in a large microwave safe bowl. Melt for 1-1½ minutes on 1100W, stirring during cooking.
2. Add sour cream and water. Cook a further 1 minute on 1100W. Mix well.
3. Stir in eggs, flour, sugar and baking powder.
4. Mix well, pour into a greased microwave safe cake container.
5. Cook for 13 minutes on 550W followed by 13 minutes on CONVECTION 130°C. Allow to stand 10 minutes before turning out.
6. Allow to cool before icing.

ICING

1. Melt chocolate and coffee for 1-2 minutes on 1100W.
2. Add sour cream and beat well.

POTATOES PIZZAIOLA

Serves 4-6

4 large potatoes
20 g butter
1 clove garlic, crushed
400 g can tomatoes, roughly chopped
2 teaspoons fresh (or 1/2 teaspoon dried) oregano
ground black pepper

1. Peel and dice potatoes into 1.5 cm cubes, rinse and place in a large microwave safe bowl with 2 tablespoons of water, cover and cook for 8 minutes on 1100W, stirring halfway through cooking. Drain.
2. In a small microwave safe bowl, combine butter and garlic and cook for 50 seconds on 1100W.
3. Combine oregano and pepper to garlic mixture.
4. Add tomatoes and garlic mixture to potatoes, ensuring potatoes are well coated.
5. Cook, uncovered, for 10 minutes on 1100W, stirring halfway through cooking.

GRILLED TOMATOES

Serves 4

2 tomatoes

1. Cut tomatoes in half.
2. Place directly onto turntable.
3. Cook for 5 minutes on GRILL.
4. Turn over, cook for 5 minutes on GRILL.

SOY AND SESAME GREEN BEANS

Serves 4

300 g green beans
1 tablespoon soy sauce
1 tablespoon olive oil
sesame seeds, to garnish

1. Cut the ends off beans and rinse well.
2. Place beans in a large square casserole dish. Pour soy sauce and oil and toss well.
3. Cook on the high rack for 12 minutes on COMBI C-3, mixing halfway through.
4. Sprinkle with sesame seeds.

PUMPKIN SALAD

Serves 6-8

1 kg pumpkin, peeled and cubed
3/4 cup walnuts
6 shallots, chopped
1/4 cup finely chopped parsley
1/2 teaspoon nutmeg
ground black pepper
1 cup mayonnaise

1. Place pumpkin in large microwave safe bowl, add 2 tablespoons of water, cover and cook for 12-14 minutes on 1100W or until pumpkin is just cooked, but still firm.
2. Refresh by running cold water over pumpkin. Drain and chill.
3. Mix walnuts, shallots, parsley, nutmeg and pepper with mayonnaise.
4. Fold mayonnaise mixture gently into the pumpkin. Serve chilled.

ROAST VEGETABLES

Serves 4

300 g baby potatoes, cut in half
300 g sweet potatoes, peeled
250 g parsnips, peeled
2 tablespoon olive oil
1 teaspoon oregano
1 teaspoon parsley
pinch of salt

1. Cut sweet potato lengthwise and into 2 cm chunks. Cut parsnips into quarters.
2. Add potatoes, sweet potatoes and parsnips into a large shallow square casserole dish. Cook, covered for 8-10 minutes on 1100W, drain.
3. Combine oil, oregano, parsley and salt. Pour over vegetables, coat evenly.
4. Cook, uncovered for 26 minutes on COMBI C-3, mixing half way through.

SQUASH WITH YOGHURT

Serves 4-6

500 g squash
200 g carton natural yoghurt
2 teaspoons seeded mustard
ground black pepper

1. Wash and trim squash. Slice thinly, place in a microwave safe glass pie plate.
2. Cover and cook for 4-6 minutes on 1100W, or until just tender. Drain juice prior to adding yoghurt.
3. Combine yoghurt, mustard and pepper and gently fold through the squash.
4. Serve hot.

HONEY GINGERED VEGETABLES

Serves 6

1/2 cup salad dressing
2 teaspoons grated ginger
2 tablespoons honey
1 tablespoon soy sauce
2 tablespoons lemon juice
500 g butternut pumpkin, peeled and thinly sliced
1 cup frozen beans
2 zucchinis, sliced
1/2 cup pecans

1. In a large microwave safe bowl, heat dressing, ginger, honey, soy sauce and lemon juice for 3-4 minutes on 1100W.
2. Add pumpkin and cook covered 4-6 minutes on 1100W, until just tender.
3. Stir in beans and zucchinis, cook covered a further 6-7 minutes on 1100W.
4. Spoon onto a serving plate. Sprinkle with pecans.

GRILLED ZUCCHINI WITH FETA AND MINT

Serves 2

300 g zucchini
approximately 100 g feta
olive oil, to brush
handful of fresh mint finely chopped

1. Cut zucchini in half, and then cut lengthwise to make 4 slices.
2. Brush each side of the zucchini with olive oil.
3. Arrange zucchini on the high rack in a circle. Cook for 20 minutes on GRILL, turning half way through.
4. Place zucchini in a bowl. Add crumbled feta and garnish with fresh mint.

POTATO, AVOCADO AND ONION SALAD Serves 6

1 kg small new potatoes
1 large onion, sliced into rings
1 tablespoon caster sugar
20 g butter
1/2 cup mayonnaise
150 mL sour cream
black pepper
1 large avocado, cubed
chives, to garnish

1. Cut unpeeled potatoes in half. Place in a large microwave safe bowl and cover with water. Cook, covered with a lid, for 18-20 minutes on 1100W (potatoes should be tender but holding their shape). Drain.
2. Place onion rings, caster sugar and butter in a microwave safe glass bowl. Cook for 4-5 minutes on 1100W, stirring halfway through.
3. Combine mayonnaise, sour cream and black pepper. Pour over potatoes.
4. Toss in onions and avocado; sprinkle with chives.
5. Chill serve.

STUFFED MUSHROOMS Serves 4

2 slices white bread
2 rashers bacon, chopped
2 shallots, finely chopped
1/2 cup grated cheddar cheese
1 tablespoon grated parmesan cheese
1 tablespoon Worcestershire sauce
1 tablespoon chopped fresh parsley
6 large flat mushrooms, stalks removed (approx. 80g each)
20 g butter

1. Process the bread into fine crumbs. Set aside.
2. Place the bacon between sheets of paper towel. Cook for 2 minutes on 1100W.
3. Place the shallots and bacon in a small microwave safe glass bowl. Cook for 1 minute on 1100W.
4. Mix the breadcrumbs, bacon, shallot, cheeses, Worcestershire sauce and parsley until well combined.
5. Spoon the mixture into the mushrooms.
6. Cut the butter into 6 equal cubes and place on each mushroom.
7. Place the filled mushrooms on the high rack. Cook for 15 minutes on Convection 200°C.

CHUNKY VEGETABLE SOUP Serves 6

1/2 cup oil
60 g butter
2 onions, peeled and chopped
3 carrots, finely chopped
1 potato, peeled and chopped
3 sticks celery, chopped
2 zucchinis, chopped
1/4 cabbage, shredded
3 cups beef stock
2 × 400 g cans peeled tomatoes
salt and pepper
parmesan cheese

1. Combine oil, butter and onion in a large casserole dish. Cook for 2-3 minutes on 1100W.
2. Add carrots and potato. Cover and cook for 5 minutes on 1100W.
3. Add celery, zucchini and cabbage. Cover and cook for 3 minutes on 1100W. Add stock, undrained tomatoes, salt and pepper. Cook, covered, for 20-25 minutes on 1100W, stirring occasionally.
4. Serve hot, topped with parmesan cheese.

STUFFED BAKED POTATOES Serves 4

4 large potatoes
1/4 cup milk
1/4 cup cream
1/2 cup grated cheddar cheese
30 g butter
2 teaspoons dried parsley flakes
1/4 teaspoon dry mustard
paprika

1. Pierce potatoes with a fork; place on turntable. Cook for 10-12 minutes on 1100W. Stand in foil for 5 minutes.
2. Cut a thin slice from top of each potato; scoop out cooked potato with a spoon, leaving a thin shell.
3. Stir milk, cream, half the cheese, butter, parsley, mustard and potato. Mix well until no lumps remain.
4. Spoon mixture into each potato shell. Place on the low rack.
5. Sprinkle with remaining cheese and paprika. Cook for 2-3 minutes on 1100W and 8 minutes on GRILL.

VEGETABLES

CAULIFLOWER AU GRATIN

Serves 4-6

500 g cauliflower florets
30 g butter
2 tablespoons flour
1 cup milk
1 teaspoon mustard
1/2 cup grated cheese
paprika

1. Place cauliflower in a glass pie dish. Cover and cook on the low rack for 4-6 minutes on 1100W, until tender. Drain.
2. Melt butter in a microwave safe glass jug for 40-50 seconds on 1100W.
3. Stir in flour. Cook for 1 minute on 1100W.
4. Gradually stir in milk and mustard. Cook for 2-2 1/2 minutes on 1100W, stirring every minute.
5. Stir in cheese until melted.
6. Pour over cauliflower. Sprinkle with paprika.
7. Cook for 6-8 minutes on GRILL.

EASY HOME-MADE RICE RISOTTO

Serves 6-8

1 onion, diced
60 g butter
4 rashers bacon, diced (optional)
(or 1 cup cooked chicken or ham)
3 chicken or beef stock cubes
2 cups boiling water
1 cup long-grain rice, well washed
1 cup assorted finely chopped vegetables,
e.g. carrots, zucchinis, mushrooms

1. Place onion, butter and bacon in large casserole dish. Cook for 3-4 minutes on 1100W. Stir well.
2. Dissolve stock cubes in boiling water; add to onion and bacon. Add all other ingredients. Cover with a lid and cook for 16-18 minutes on 1100W. Do not stir while cooking.
3. At the end of this time, all the liquid will have been absorbed.
4. Leave to stand for 5 minutes and stir with a fork before serving.

SCALLOPED POTATOES

Serves 4-6

3 large potatoes (approx. 500 g), peeled and sliced thinly
1/4 cup water
1 large onion, sliced
200 g carton light sour cream
1 egg
90 g cheddar cheese, finely grated
paprika

1. Place potatoes in a round or oval shallow dish, add water, cover, and cook for 6-8 minutes on 1100W.
2. Drain off water.
3. Arrange sliced onion over potatoes.
4. Combine sour cream and egg. Mix well and pour over potatoes. Sprinkle with cheese and a little paprika if desired.
5. Cook uncovered, using the low rack on COMBI C-3 for 15-17 minutes.

HONEY CARROTS

Serves 4

500 g carrots, sliced lengthwise
60 g butter
1 tablespoon honey

1. Combine all ingredients in a casserole dish.
2. Cover and cook for 6-8 minutes on 1100W.
3. Stand covered for 3 minutes before serving.

VEGETABLE PLATTER

Serves 4

200 g carrots, sliced
200 g broccoli, cut into florets
100 g zucchinis, sliced

1. Arrange vegetables in a glass pie dish with the harder vegetables positioned around the outside and the softer vegetables in the centre.
2. Cover with plastic wrap.
3. Cook for 4 1/2-5 1/2 minutes on 1100W.
4. Stand covered for 3 minutes before serving.

OYSTERS KILPATRICK

Serves 1-2

3 rashers bacon, chopped
1 dozen oysters in the half shell
2 tablespoons worcestershire sauce

1. Place bacon in a small microwave safe bowl, cover and cook for 3 minutes on 1100W.
2. Sprinkle bacon over top of oysters, and add sauce. Place on the high rack and cook for 8-10 minutes on GRILL.

PRAWN CUTLETS

Serves 4

16 green king prawns
1/2 cup breadcrumbs
1/4 cup plain flour
1 egg (lightly beaten)
2 tablespoons olive oil

1. Peel prawns, leaving tails intact and devein.
2. Cut prawn down the back, flatten slightly with hand to form a cutlet shape.
3. Dust prawns lightly with flour, dip into egg, and coat with breadcrumbs.
4. Line the high rack with foil and spray with non-stick spray.
5. Place prawns onto the high rack and cook for 5 minutes on COMBI C-3.
6. Turn prawns over and cook for a further 5 minutes on COMBI C-3.
7. Serve with tartare sauce.

SQUID IN TOMATO AND WINE SAUCE Serves 6

500 g squid tubes
1 tablespoon soy sauce
1 tablespoon cornflour
1 tablespoon olive oil
1 shallot, chopped
1 clove garlic, crushed
400 g can tomato, diced
1/4 cup dry white wine
2 tablespoons tomato paste
1 tablespoon chopped fresh basil

1. Cut squid tubes into rings. Sprinkle with combined soy sauce and cornflour. Refrigerate for 30 minutes.
2. Combine oil, onion and garlic in a large microwave safe bowl. Cook for 1 minute on 1100W.
3. Stir in tomatoes, white wine and tomato paste. Cook for 5-6 minutes on 1100W.
4. Stir in squid. Cook for 10-12 minutes on 550W, tossing every minute until squid is firm.
5. Sprinkle with fresh basil.
6. Serve with French bread and tossed salad.

BOUILLABAISSE Serves 8

6 mussels
750 g scallops
500 g green prawns, peeled and deveined
500 g firm fish fillets, cut into bite-size pieces
5 crab sticks, sliced
6 oysters
1 tablespoon olive oil
1 onion, finely chopped
1 clove garlic, crushed
1 1/2 cups fish stock
425 g can tomatoes, puréed
1/2 cup white wine
2 tablespoons tomato paste
1/4 teaspoon turmeric
grated rind of 1 lemon
salt and pepper
1/4 cup chopped fresh basil

1. Wash and clean seafood.
2. Cook oil, onion and garlic in a large casserole dish for 1-2 minutes on 1100W
3. Stir in fish stock, tomatoes, white wine and tomato paste. Cover and cook for 8 minutes on 1100W, stirring halfway through cooking.
4. Place mussels into hot stock, cover and simmer for 8-10 minutes on 770W or until mussels open. Discard any which stay closed.
5. Stir in scallops, prawns, turmeric, lemon rind, salt and pepper. Cover and cook for 5-6 minutes on 770W.
6. Stir in fish fillets, crab sticks and oysters. Cover and cook for 14-16 minutes on 770W or until fish flakes.
7. Garnish with fresh basil.

CURRIED SCALLOPS Serves 4

40 g butter
1 onion, finely chopped
1/2 teaspoon ground cumin
1/2 teaspoon ground coriander
1/2 teaspoon ground turmeric
1/2 lemon, juiced
1/4 cup cream
500 g scallops
1 tablespoon fresh coriander

1. In a large microwave safe glass bowl, combine the butter, onion, cumin, ground coriander, turmeric and lemon juice. Cover and cook for 5-6 minutes on 1100W.
2. Stir in the cream, blending well.
3. Add the scallops. Cook for 8-10 minutes on 550W, stirring every 2 minutes.
4. Serve with rice and garnish with fresh coriander.

SEAFOOD LASAGNE

Serves 6-8

125 g butter
1½ cups plain flour
1 teaspoon dry mustard
4 cups milk

500 g seafood marinara
1 packet fresh lasagne sheets
1½ cups grated tasty cheese

1. Melt butter in a large microwave safe bowl for 1-2 minutes on 1100W.
2. Stir in flour and dry mustard. Cook for 1½ minutes on 1100W.
3. Gradually stir in milk. Cook for 6-8 minutes on 1100W or until sauce is thick. Stir every 2 minutes.
4. Stir in marinara. Cook for 4-6 minutes on 550W.
5. Layer sheets over base of a 2 litre square casserole dish.
6. Cover noodles with ⅓ marinara sauce and ½ cup cheese. Repeat process, ending with marinara sauce and cheese.
7. Cook for 16-19 minutes on COMBI C-3 and 3 minutes on GRILL.
8. Allow to stand for 10 minutes before serving.

SESAME PRAWNS

Serves 4

24 green king prawns (approx. 1 kg)
1 clove garlic
1 tablespoon ketjap manis
2 teaspoons sesame oil
1 tablespoon sesame seeds
6 bamboo skewers

1. Peel prawns, leaving tails intact, and devein. Place in a shallow dish.
2. Combine garlic, ketjap manis, sesame oil and sesame seeds. Pour over prawns. Cover and refrigerate for 1-2 hours.
3. Thread 3-4 prawns onto each bamboo skewer. Coat in sesame seeds.
4. Place skewers on the high rack. Cook for 15-17 minutes on GRILL. Turn over halfway.
5. Serve with satay sauce and rice.

CRAB MORNAY

Serves 6

60 g butter
⅓ cup plain flour
½ teaspoon dry mustard
2 cups milk
1 onion, finely chopped

2 × 170 g cans crab meat, drained
salt and pepper
½ cup finely grated cheese
2 tablespoons cornflake crumbs

1. In a large microwave safe bowl, melt butter for 1-1½ minutes on 1100W. Stir in flour and mustard. Cook for a further 1 minute on 1100W.
2. Gradually stir in milk. Cook for 4-5 minutes on 1100W, stirring every 2 minutes.
3. Stir in onion, crab meat, salt and pepper and ¼ cup cheese.
4. Place into a 1 litre serving dish. Sprinkle with cornflake crumbs and remaining cheese.
5. Cook for 13-15 minutes on GRILL.
6. Serve with fresh garden salad.

GARLIC MUSSELS

Serves 4 as entree

500 g mussels
1 cup wine
2 cups water
1 clove garlic, crushed

GARLIC BUTTER
40 g butter
2 tablespoons olive oil
2 cloves garlic, crushed
pepper

1. Wash mussels under running water; remove all traces of mud, seaweed and barnacles with brush or knife; remove beards. Discard cracked, broken or open mussel shells.
2. In a large microwave safe bowl, cover mussels with wine, water and garlic. Cook for 16-18 minutes on 550W or until open, removing from liquid as they open. Discard unopened mussels.

GARLIC BUTTER

1. Melt butter in a microwave safe jug for 30 seconds on 1100W, add oil, garlic and pepper.
Pour ½ garlic sauce over mussels; toss well.
2. Arrange mussels in serving bowl and pour remaining sauce over mussels.

SCALLOPS IN BLACK BEAN SAUCE Serves 4

1 tablespoon oil	2 teaspoons sugar
2 spring onions, finely sliced	1 tablespoon soy sauce
1 chilli, seeded and finely chopped	2 tablespoons black bean sauce
1 tablespoon cornflour	500 g scallops

1. In a large microwave safe bowl combine oil, onions and chilli; cook for 1 minute on 1100W.
2. Stir in cornflour, sugar, soy sauce and black bean sauce.
3. Add scallops; stir well.
4. Cook for 10-12 minutes on 550W, stirring twice during cooking.

CRISPY MARINATED CRAB STICKS Makes 24

12 crab sticks	1 teaspoon sugar
2 tablespoons lemon juice	1/4 cup oil
1 clove garlic, crushed	1 tablespoon soy sauce
2 teaspoons grated ginger	8 rashers bacon, rind removed

1. Cut crab sticks in half.
2. Place lemon juice, garlic, ginger, sugar, oil and soy sauce in a bowl. Mix well.
3. Place crab sticks in marinade and allow to stand 2 hours. Drain.
4. Cut bacon into 3 pieces. Wrap each piece around each crab stick; secure with a toothpick.
5. Place on the low rack.
6. Cook for 14-16 minutes on COMBI C-3.
7. Cook for 1½ minutes on GRILL.

TAGLIATELLE AND CRAB SALAD Serves 6-8

500 g tagliatelle pasta	1/2 cup French dressing
12 crab sticks, sliced	300 mL cream
1/2 cup toasted pine nuts	salt and pepper
6 shallots, chopped	

1. Place tagliatelle into a large microwave safe bowl. Cover with hot tap water. Cook for 14-16 minutes on 1100W, until tender. Drain well.
2. Toss sliced crab sticks, pine nuts and shallots through pasta.
3. Mix French dressing and cream. Season with salt and pepper. Pour over pasta. Toss well.

PRAWN CREOLE Serves 4

20 g butter	1 cup chicken stock
1 medium onion, chopped	1 tablespoon parsley
1 capsicum, chopped	2 teaspoons sugar
1 stick celery, sliced	1/2 teaspoon salt
2 tablespoons flour	1/2 teaspoon chilli powder
400 g can whole tomatoes	500 g green prawns, peeled and deveined
1/2 cup tomato paste	

1. In a large microwave safe bowl, combine butter, onion, capsicum and celery. Cook for 4-5 minutes on 1100W.
2. Stir in flour, tomatoes, tomato paste, chicken stock, parsley, sugar, salt and chilli powder; mix well.
3. Cook, uncovered, for 5 minutes on 1100W, stirring once.
4. Add prawns and cook for 18-20 minutes on 550W, stirring twice. Serve with rice.

SEAFOOD

MARINATED BABY OCTOPUS

Serves 2

400 g baby octopus
2 tablespoons balsamic vinegar
1 clove garlic, crushed
2 tablespoons chopped fresh coriander
1 fresh chilli seeded and chopped
extra coriander, to garnish
lime wedges, to serve

1. Rinse the octopus thoroughly, making sure the heads are clean. Large pieces of octopus should be cut into smaller pieces to ensure even cooking.
2. In a large bowl, combine balsamic vinegar, garlic, coriander and chilli.
3. Transfer the rinsed octopus to the bowl containing the sauces. Cover and refrigerate for at least 2 hours, or overnight.
4. Arrange the marinated octopus in a shallow microwave safe glass dish. Place on the high rack. Cook for 16-18 minutes on COMBI C-3, turning half way through; a shorter or longer cooking time may be necessary depending on your preference of texture.
5. Garnish with the coriander leaves and serve with the lime wedges or salad greens.

CHEESY SALMON CANNELLONI

Serves 4-6

ROLLS

120 g cannelloni
250 g ricotta cheese
90 g cheddar cheese, grated
salt and pepper to taste
2 eggs, lightly beaten
210 g can red salmon, drained
2 teaspoons lemon juice
2 tablespoons cheddar cheese, extra

1. Combine ricotta cheese, cheddar cheese, salt and pepper, eggs, salmon and lemon juice; mix well.
2. Place a spoonful of salmon mixture into each cannelloni. Place in a single layer in a shallow heat-proof dish.

SAUCE

1. Combine cornflour with 2 tablespoons of tomato purée to form a smooth paste. Stir in remaining purée and parsley.
2. Pour tomato purée over salmon rolls and cook covered for 16-18 minutes on 770W or until cannelloni is tender.
3. Sprinkle the extra cheese over the pasta. Cover and cook for 2-3 minutes on 770W.

GARLIC PRAWNS

Serves 4

24 green king prawns
40 g butter
3 cloves garlic, crushed
1/3 cup olive oil
1 tablespoon chopped parsley

1. Peel and devein prawns, leaving tails intact.
2. Combine butter and garlic in a large microwave safe bowl. Cook for 1 1/2-2 minutes on 1100W.
3. Stir in oil and prawns.
4. Cook for 4-6 minutes on 550W, tossing every 2 minutes. Sprinkle with parsley.
5. Serve in individual dishes with garlic bread.

CHICKEN CACCIATORE

Serves 6

6 chicken thighs
1/4 cup flour
1 tablespoon Season All salt
1 onion, sliced
30 g butter
1 clove garlic, crushed
2 tablespoons tomato paste
440 g can peeled tomatoes
2 chicken stock cubes
1/2 cup white wine
1 green capsicum, thinly sliced
6 black olives, sliced

1. Place chicken, flour and season all salt into a freezer bag. Toss until chicken is coated.
2. Combine chicken thighs, remaining flour, onion, butter, garlic, tomato paste, juice from tomatoes, stock cubes and white wine in a 5 litre casserole dish.
3. Cover and cook for 26-28 minutes on 770W. Stir 2-3 times during cooking.
4. Add capsicum and chopped tomatoes. Cover and cook a further 10-12 minutes on 770W.
5. Garnish with black olives.

CRUNCHY CAMEMBERT CHICKEN

Serves 6

125 g camembert cheese, finely chopped
2 rashers bacon, finely chopped
1/2 cup toasted, slivered almonds
2 tablespoons seeded mustard
Approx. 1.5 kg chicken
2 tablespoons honey

1. Mix camembert, bacon, almonds and 1 tablespoon mustard together in a small bowl.
2. Press camembert mixture between skin and flesh of chicken. Tie chicken legs together.
3. Mix remaining mustard and honey. Brush over chicken.
4. Place breast side down on the low rack, cook for 40 minutes on Convection 200°C.
5. Turn chicken over and brush with remaining mixture. Cook for a further 20 minutes on COMBI C-3.
6. Allow to stand covered with foil for 10 minutes before serving.

CHICKEN FILLET BURGERS

Serves 4

4 chicken breast fillets (approx. 500 g)
2 tablespoons flour
1 teaspoon paprika
2 slices ham, sliced in half
2 slices pineapple, sliced in half
4 slices cheese

1. Place chicken, flour and paprika into a freezer bag. Toss until chicken is coated.
2. Place chicken fillets in a dish.
3. Cook for 8-10 minutes on 770W, turning over halfway through cooking.
4. Place ham and pineapple slices on top of each chicken piece.
5. Top with cheese.
6. Cook for 10 minutes on GRILL.
7. Serve on a hamburger bun with lettuce and tomato.

ROAST CHICKEN

Serves 4

Approx. 1.5 kg chicken
30 g butter, melted
Season All salt

1. Wash and dry chicken well.
2. Tie legs of chicken together with string.
3. Place breast-side down on the low rack.
4. Baste with butter and sprinkle with Season All salt.
5. Cook for 40 minutes on convection 200°C.
6. Turn chicken over. Baste with butter and sprinkle with Season All salt.
7. Cook for a further 20 minutes on COMBI C-3.
8. Allow to stand covered with foil for 10 minutes before serving.

CHICKEN AND MACARONI BAKE

Serves 4-6

1 cooked chicken (approx. 1.5 kg)
20 g butter, melted
2 cups macaroni
1/4 cup plain flour
300 mL sour cream
1 cup chicken stock
1 cup grated cheese
1 tablespoon chopped parsley

1. Place macaroni in a large microwave safe bowl. Cover with hot water. Cook for 16 minutes on 1100W, stirring half way through or until pasta is tender. Drain.
2. Remove flesh from chicken.
3. Mix together plain flour, sour cream and chicken stock.
4. Combine chicken, macaroni and sauce mixture in a 3 litre casserole dish. Sprinkle with cheese and cook for 10-12 minutes on 770W and 4-5 minutes on GRILL.
5. Sprinkle with parsley.
6. Serve immediately with a tossed salad.

APRICOT CHICKEN

Serves 4

4 chicken thighs
1 packet French onion soup
2 tablespoons plain flour
125 mL apricot nectar
825g can apricot halves, drained

1. Toss chicken in combined French onion soup and plain flour.
2. Place in a 3 litre casserole dish.
3. Cook chicken for 13-15 minutes on 770W. Turn chicken over.
4. Pour over apricot nectar and apricots.
5. Cook, covered, for 13-15 minutes on 770W.
6. Serve hot with pasta.

CHEESE AND HERB CHICKEN LEGS

Serves 4

2 tablespoons chopped parsley
1 teaspoon basil
2 teaspoons tarragon
2 teaspoons dill
2 teaspoons mustard powder
1 teaspoon paprika
salt and pepper
1 teaspoon sesame seeds
90 g butter, melted
8 large chicken drumsticks
125 g country cheese biscuits, crushed

1. Mix parsley, basil, tarragon, dill, mustard powder, paprika, salt and pepper, sesame seeds and one-third of butter together in a small bowl.
2. Using a sharp knife, lift skin back from the chicken drumsticks.
3. Spread a teaspoon of herb mixture between skin and chicken.
4. Brush chicken with remaining butter, coat with biscuit crumbs.
5. Place on the high rack and cook for 25 minutes on Convection 200°C.
6. Turn over and cook for a further 15 minutes on COMBI C-3.
7. Allow to stand for 5-10 minutes before serving.

HONEY CHICKEN LEGS

Serves 4

250 mL soy sauce
4 tablespoons honey
1 tablespoon lemon juice
1 clove garlic, crushed
1/2 teaspoon freshly grated ginger
2 tablespoons oil
8 large chicken legs
sesame seeds

1. Combine soy sauce, honey, lemon juice, garlic, ginger and oil in a small bowl. Pour over chicken and marinate for 2-3 hours.
2. Arrange the chicken legs on the high rack lined with foil. Cook for 25 minutes on Convection 200°C.
3. Turn chicken over and cook for a further 15 minutes on Convection 200°C.
4. Sprinkle with sesame seeds.

CHICKEN PROVENCALE

Serves 4

1/2 cup white wine
425 g can peeled tomatoes
1 large onion, chopped
1 apple, peeled and chopped
1/2 cup black olives

1 teaspoon curry powder
1.25 kg chicken pieces, skin removed
(or 4 marylands)
250 g button mushrooms, sliced
chopped parsley

1. In a large jug combine wine, tomatoes, onion, apple, olives and curry powder. Mix well.
2. Arrange chicken pieces in a casserole dish. Pour over sauce. Cover and cook for 27-29 minutes on 770W. Stir once during cooking.
3. When oven stops, stir in mushrooms. Cover and cook for a further 5-7 minutes on 770W.
4. Sprinkle with parsley.

CHICKEN TERRINE

Serves 6-8

60 g butter
6 shallots, chopped
1/2 cup flour
1 cup chicken stock
1 cup milk
1/4 teaspoon tabasco sauce
pepper

250 g cream cheese, softened
1 cooked chicken, chopped
2 teaspoons green peppercorns, chopped
3 teaspoons gelatine
1/2 cup water
6 rashers bacon

1. Melt butter in a microwave safe bowl for 40 seconds on 1100W. Add shallots and flour. Cook for 1 minute on 1100W.
2. Gradually stir in stock and milk. Cook for 4-5 minutes on 1100W, stirring every 2 minutes.
3. Stir in tabasco sauce and pepper.
4. Beat cream cheese. Gradually stir in the sauce. Add chicken and peppercorns.
5. In a small microwave safe bowl dissolve gelatine in water. Cook for 40 seconds - 1 minute on 1100W; add to chicken mixture.
6. Line 25 cm x 11 cm loaf dish with paper towel and place bacon across paper towel.
7. Cover with paper towel and cook for 3-5 minutes on 1100W.
8. Remove top layer of paper towel.
9. Pour in chicken mixture. Refrigerate overnight.
10. Turn out and slice. Serve with Melba toast.

WHOLEMEAL CHICKEN

Serves 4

1 kg chicken thighs
100 g butter, melted
1/4 cup finely grated parmesan cheese
1 cup wholemeal flour
1 tablespoon chopped parsley

1. Dip chicken thighs in butter.
2. Coat with combined cheese, flour and parsley.
3. Place on the low rack. Cook for 14 minutes on COMBI C-3 and 5-6 minutes on GRILL.
4. Turn over and cook for a further 8-9 minutes on GRILL.

TANDOORI CHICKEN

Serves 4-6

2 fresh red chillies, seeded
1 onion
2 cloves garlic, crushed
2 teaspoons crushed ginger
2 tablespoons lemon juice
2 teaspoons ground cumin
1/2 teaspoon black pepper
1/2 teaspoon salt
3 teaspoons ground coriander

2 whole cloves
1/4 teaspoon cinnamon
1 bay leaf
1/2 teaspoon turmeric
1/2 teaspoon nutmeg
2 teaspoons paprika
6 chicken thighs, skin removed
1 tablespoon vinegar
200 g low-fat yoghurt

1. Purée chillies, onion, garlic, ginger and lemon juice until smooth.
2. Mix cumin, pepper, coriander, cloves, cinnamon, bay leaf, turmeric, nutmeg and paprika in a small microwave safe bowl.
3. Cook for 1 minute on 1100W, stirring halfway through cooking. Remove bay leaf and cloves.
4. Combine chilli mixture and spices together. Spread over chicken.
5. Sprinkle with vinegar and pour over yoghurt. Cover and marinate overnight, stirring occasionally.
6. Place on the high rack, cook for 25 minutes on COMBI C-3.
7. Turn over and cook for a further 25 minutes on COMBI C-3.
8. Serve with boiled rice.

POULTRY

CHICKEN IN A POT

Serves 4-6

1.5 kg chicken thighs
1/4 cup plain flour
2 rashers bacon, finely chopped
1 green capsicum, diced
1 onion, finely chopped
400 g can peeled tomatoes

2 tablespoons tomato paste
2 chicken stock cubes
1 tablespoon soy sauce
salt and pepper
200 g mushrooms, sliced

1. Toss chicken thighs in flour.
2. Combine all ingredients, except mushrooms, in a 3 litre casserole dish.
3. Cover and cook for 30 minutes on 770W. Stir 2-3 times during cooking.
4. Add mushrooms. Cook, uncovered, a further 5-7 minutes on 770W.

CHICKEN FRICASSEE

Serves 4

1 large cooked chicken
60 g butter
3 tablespoons flour
2 cups chicken stock
1 egg yolk

1/4 cup cream
1/4 teaspoon nutmeg
300 g jar artichoke hearts, halved
4 slices processed cheese
chopped parsley

1. Remove meat from chicken and chop into cubes.
2. Melt butter for 40-50 seconds on 1100W in a microwave safe jug. Stir in flour; cook a further 40 seconds.
3. Gradually stir in chicken stock. Cook for 5-6 minutes on 1100W, stirring halfway through cooking.
4. Stir in chopped chicken, egg yolk, cream, nutmeg and artichokes.
5. Pour into a 2 litre casserole dish. Cover and cook for 4-6 minutes on 770W. Stir well.
6. Lay cheese slices across middle of dish. Cook a further 10-12 minutes on 770W.
7. Sprinkle with parsley.

CHICKEN WITH BACON AND LEEK SEASONING

Serves 4

Approx. 1.5 kg chicken
60 g butter, melted
1 leek, finely chopped
2 rashers bacon, chopped

1 1/2 cups wholemeal breadcrumbs
1 egg yolk
salt and pepper

1. Combine butter, leek and bacon in a microwave safe bowl. Cook for 1-2 minutes on 1100W.
2. Stir in breadcrumbs, egg yolk and seasonings. Mix well.
3. Fill cavity of chicken with stuffing and secure with a toothpick.
4. Place chicken on the low rack, breast-side down, cook for 12-14 minutes on COMBI C-3 and 7 minutes on GRILL.
5. Turn over, cook a further 12-14 minutes on COMBI C-3 and 7 minutes on GRILL.
6. Stand covered with foil for 10 minutes before carving.

CHICKEN AND APRICOT SALAD

Serves 6

Approx. 1.5 kg chicken
20 g butter
1/2 cup mayonnaise
1/4 cup sour cream
1 tablespoon lemon juice
6 ripe fresh apricots, cut into wedges
2 sticks celery, thinly sliced
1/4 teaspoon dried tarragon

1. Melt butter in a microwave safe bowl for 20 seconds on 1100W, brush chicken with butter. Cook on the low rack for 12-14 minutes on COMBI C-3 and 7 minutes on GRILL.
2. Turn over, brush chicken with butter, and cook for a further 12-14 minutes on COMBI C-3 and 7 minutes on GRILL.
3. Remove chicken flesh from the bone.
4. Combine mayonnaise, sour cream and lemon juice. Stir in apricots, chicken, celery and tarragon until coated. Chill for 1-2 hours.
5. To serve, line a salad bowl with lettuce leaves. Spoon in salad.

NOTE: Leftover turkey may be substituted for chicken.

HAMBURGER

Serves 6

- 500 g mince
- 1 onion, chopped
- 1 egg
- 1 tablespoon tomato sauce
- 1 teaspoon mixed herbs
- 1 teaspoon seasoned pepper
- $\frac{3}{4}$ cup breadcrumbs

1. In a large bowl, combine mince, onion, egg, tomato sauce, mixed herbs, seasoned pepper and breadcrumbs.
2. Shape into 6 equal patties. Place patties on the high rack lined with foil. Cook for 15 minutes on COMBI C-3.
3. Drain juices, turn patties over and cook for a further 15 minutes on COMBI C-3.
4. Serve on hamburger bun with lettuce and tomato.

GRILLED KEBABS

Serves 4

- 400 g lamb
- 1 large onion, coarsely chopped
- 1 green capsicum, coarsely chopped

1. Cut lamb into cubes.
2. Thread capsicum, onion and chicken onto 8 skewers.
3. Place on the high rack and cook for 10-15 minutes on GRILL.
4. Turn over and cook for a further 10-15 minutes on GRILL.
5. Serve on a bed of rice.

PORK RIBS WITH CHILLI PLUM SAUCE

Serves 4

- 750 g pork ribs
- 1 tablespoon oyster sauce
- 2 tablespoons dry sherry
- 1 tablespoon soy sauce
- 3 teaspoons black beans sauce
- 1 $\frac{1}{2}$ teaspoons five spice powder
- $\frac{1}{2}$ teaspoon pepper
- $\frac{1}{4}$ teaspoon salt

CHILLI PLUM SAUCE

- 2 teaspoons oil
- 1 clove garlic
- $\frac{1}{2}$ teaspoon grated green ginger
- 2 shallots, chopped
- 210 mL bottle plum sauce
- $\frac{1}{2}$ teaspoon chilli sauce
- 1 chicken stock cube
- $\frac{1}{3}$ cup water
- 2 teaspoons soy sauce
- 2 teaspoons cornflour

Sauce Method

1. In a large microwave safe bowl combine the oil, crushed garlic, ginger, chopped shallots. Cook for 1-2 minutes on 1100W.
2. Add plum and chilli sauce, stir until combined.
3. Combine water, stock cube, soy sauce and cornflour. Add to mixture. Cook for a further 2 minutes on 1100W, until mixture begins to thicken.

Method

1. Remove excess fat from ribs.
2. In a large bowl combine oyster sauce, sherry, soy sauce, black beans sauce, five spice powder, pepper and salt.
3. Dip each rib into black bean mixture. Place ribs on the high rack lined with foil. Cook for 15 minutes on COMBI C-3.
4. Turn ribs over, brush each side with chilli plum sauce. Cook for a further 10 minutes on COMBI C-3 or until golden brown.
5. Serve with remaining sauce.

BREAKFAST GRILL

Serves 1

- 1 flat mushroom (approx. 80g)
- $\frac{1}{2}$ tomato
- 1 rasher bacon
- 1 thick sausage
- 1 egg

1. Place mushroom, tomato, sausage (pierced 3 times), bacon and egg on the high rack lined with foil. Cook for 10 minutes on COMBI C-3.
2. Turn food over and cook for a further 10 minutes on COMBI C-3.

APRICOT AND ALMOND CRUSTY LAMB Serves 4

200 g dried apricots, finely chopped
1 cup fresh breadcrumbs
1/2 cup ground almonds
2 teaspoons dried rosemary
1 egg, lightly beaten
1 rack of lamb (approx. 8 chops)
1 tablespoon apricot jam

1. Mix together in a small bowl, apricots, breadcrumbs, ground almonds, rosemary and egg.
2. Brush lamb with apricot jam.
3. Place apricot crust on top of lamb.
4. Place on the low rack. Cook for 22-24 minutes on 550W and 3 minutes on GRILL. Allow to stand 10 minutes covered with foil before carving.

FILLET MIGNON Serves 4

4x scotch fillet steaks, approx 2.5 cm thick (approx. 200 g each)
4 rashers bacon

1. Remove rind of bacon.
2. Wrap 1 rasher of bacon around each fillet, secure with a toothpick.
3. Place on the high rack lined with foil.
4. Cook for 8 minutes on COMBI C-3.
5. Turn over and drain juices, cook for a further 5 minutes on COMBI C-3.
6. Remove toothpick before serving.
7. Serve with mushroom sauce.

HONEY ROAST LAMB Serves 4-6

1.5 kg leg lamb
3 tablespoons honey
1 tablespoon Dijon mustard

1. Combine honey and Dijon mustard in a small bowl.
2. Place fat-side down on the low rack.
3. Preheat to Convection 200°C. Place lamb leg on the low rack and cook for 50 minutes at 200°C. Turn over half way through cooking.
4. Allow to stand 10 minutes covered with foil before carving.

SPINACH LOIN OF LAMB Serves 4-6

1.0 kg loin of lamb
1 large spinach leaf, shredded
20 g butter
1 large onion, chopped
salt and pepper

1. Butterfly loin of lamb and flatten slightly with a meat mallet.
2. Spread with shredded spinach.
3. Place butter and onion in a microwave safe glass bowl. Cook for 3 minutes on 1100W. Sprinkle over spinach.
4. Season with salt and pepper.
5. Roll up loin and secure with string.
6. Preheat oven to Convection 200°C. Place lamb on the low rack and cook for 50 minutes at 200°C. Turn over half way. Stand for 20 minutes before serving.

BEEF MADEIRA

Serves 4-6

750 g blade or round steak, cubed **1/2 cup beef stock**
1/4 cup plain flour **1/2 cup madeira or sherry**
1 large onion, sliced **1/2 teaspoon paprika**
2 carrots, thinly sliced **350 g beans, washed and sliced**
1 clove garlic, crushed **1 green capsicum, sliced**

1. In a 3 litre casserole dish, combine meat and flour; mix well.
2. Add onions and carrots.
3. In a jug, combine garlic, beef stock, madeira or sherry, and paprika; stir well. Pour over beef.
4. Cook, covered, for 20-22 minutes on 550W, stirring 2-3 times during cooking.
5. Add beans and capsicum. Cover and cook a further 24-26 minutes on 550W, stirring twice during cooking.

TROPICAL LAMB CURRY

Serves 4-6

1 onion, thinly sliced
1 kg lamb, trimmed and cubed
1 cup chicken stock
1 teaspoon chicken stock powder, extra
3 teaspoons curry powder
810 g can apricot halves, drained, reserving 1/2 cup syrup
2 tablespoons arrowroot

1. Place onion, lamb, chicken stock, stock powder and curry powder into a 3-litre casserole dish.
2. Cover and cook for 28-30 minutes on 550W; stir twice during cooking.
3. Drain lamb and reserve 1/2 cup of liquid.
4. Combine liquid, apricot syrup and arrowroot. Cook for 1-2 minutes on 1100W.
5. Combine lamb, apricots and stock mixture and liquid, together in a 3 litre casserole dish and cover.
6. Heat through for 12-14 minutes on 550W.
7. Serve with boiled rice.

MINTED PICNIC LOAF

Serves 6-8

2 cups stale breadcrumbs **500 g minced beef**
1/2 cup milk **1/2 cup tomato sauce**
1 large potato, grated **2 tablespoons chopped fresh mint**
500 g sausage mince

TOPPING

1 cup grated fresh parmesan cheese
1 cup stale breadcrumbs
1 tablespoon chopped fresh mint

1. Combine breadcrumbs and milk in large bowl; stand for 5 minutes.
2. Add potato, mince, tomato sauce and mint to breadcumb mixture; mix well.
3. Press mixture into an 11 cm x 25 cm loaf dish lined with baking paper.
4. Place on low rack. Cook for 25-28 minutes on 550W.
5. Drain excess liquid from loaf dish.

TOPPING

1. Combine topping ingredients and press evenly over loaf. Cook for a further 3-4 minutes on GRILL.
2. Allow to stand 10 minutes before turning out. Serve hot or cold.

CHILLI CON CARNE

Serves 4-6

1 kg mince **1 tablespoon vinegar**
1 large onion, finely chopped **1 teaspoon sugar**
825 g can peeled tomatoes **375 g jar tomato paste**
salt and pepper **425 g can red kidney beans, drained**
1-2 teaspoons chilli powder

1. Mix mince and onion together in a large microwave safe bowl. Cook for 10-12 minutes on 770W, stirring every 2 minutes.
2. Stir in tomatoes, salt and pepper, chilli powder, vinegar, sugar, tomato paste and kidney beans.
3. Cook for 20-22 minutes on 770W, stirring twice during cooking.
4. Serve with boiled rice.

VEAL À LA MEDALLION

Serves 4-6

1 kg veal, cubed
1/2 cup plain flour
salt and pepper
3/4 cup water
1 cup finely chopped shallots
2 carrots, thinly sliced

1/2 teaspoon grated lemon rind
2 rashers bacon, chopped
250 g fresh mushrooms, sliced
300 mL carton sour cream
1 tablespoon chopped chives

1. Toss veal in flour. Place in a 3 litre casserole dish. Stir in salt, pepper, water, shallots, carrots, lemon rind and bacon.
2. Cover and cook for 40 minutes on 550W, stirring 2-3 times during cooking.
3. Stir in mushrooms and sour cream.
4. Cover and cook a further 5-7 minutes on 550W.
5. Sprinkle with chives.

VEAL AND PINEAPPLE

Serves 4-6

2 tablespoons flour
2 teaspoons mixed herbs
1 teaspoon chicken stock powder
black pepper
750 g veal, diced
4 rashers bacon, chopped
3 shallots, chopped
440 g can pineapple pieces, drained
1 cup tomato sauce
2 tablespoons chopped parsley

1. Mix first 4 ingredients together in a large casserole dish.
2. Add the veal; toss to coat in the seasonings. Stir in bacon, shallots, pineapple pieces and tomato sauce.
3. Cover and cook for 35 minutes on 550W, stirring 2-3 times during cooking.
4. Sprinkle with parsley and serve with rice.

HERBED LOIN OF LAMB

Serves 8

1/2 cup white wine
1/4 cup oil
3 cloves garlic, crushed
freshly ground black pepper
1 teaspoon rosemary spikes
1 kg loin of lamb

1. Mix all ingredients except lamb together to form a marinade in a small bowl.
2. Place loin of lamb in a large shallow dish and pour over marinade; leave overnight.
3. Remove loin of lamb from marinade and roll loin tightly, securing with string.
4. Preheat oven to Convection 200°C. Place lamb on the low rack and cook for 50 minutes at 200°C. Turn over half way.
5. Allow to stand 10 minutes covered with foil before carving.

ITALIAN SPAGHETTI SAUCE

Serves 4-6

500 g topside mince
1 onion, chopped
1 clove garlic, crushed
400 g can whole tomatoes
1/2 cup tomato paste
100 g mushrooms, sliced
1 tablespoon chopped parsley
1 teaspoon salt
1/2 teaspoon dried oregano leaves
1/2 teaspoon dried basil leaves

1. Mix mince, onion and garlic together in a large microwave safe bowl. Cook for 8-10 minutes on 770W, stirring every 2 minutes. Drain well.
2. Stir in canned tomatoes, tomato paste, mushrooms, parsley, salt, oregano and basil.
3. Cook a further 8-11 minutes on 770W. Stir halfway through cooking.
4. Serve over hot spaghetti.

SPRINGTIME LAMB CASSEROLE

Serves 4

1 packet (40 g) French onion soup
1/4 cup plain flour
750 g lamb, cubed
4 spring onions, quartered
2 carrots, thinly sliced
1 cup chicken stock
310 g can corn kernels, drained
2 sticks celery, finely chopped
300 mL carton sour cream

1. Combine French onion soup mix and flour in a 2-3 litre casserole dish. Toss the lamb in flour mixture, coating thoroughly.
2. Add onions and carrots, stir in chicken stock and mix well.
3. Cover and cook for 22-24 minutes on 550W, stirring during cooking.
4. Add corn, celery and sour cream. Mix well.
5. Cook a further 16-18 minutes on 550W.

CURRIED SAUSAGES

Serves 4-6

1 kg sausages	3 teaspoons curry powder
40 g butter	1/4 cup sultanas
2 onions, chopped	1 beef stock cube
1 small Granny Smith apple, peeled and finely chopped	1 1/2 cups water
	1/4 cup flour

1. Pierce sausages with a fork twice.
2. Cook for 14-16 minutes on 550W, turning halfway through cooking. Cut sausages into thirds.
3. In a 2-3 litre casserole dish, place butter, onions, apple, curry powder and sultanas; mix well. Cover and cook for 4-6 minutes on 1100W.
4. Dissolve stock cube in water.
5. Mix in flour and stock, cover and cook for 4-5 minutes on 1100W, stirring once.
6. Add sausages and stir.
7. Cover and cook for an extra 6-7 minutes on 550W. Serve with boiled rice or noodles.

BEEF STROGANOFF

Serves 6

1 kg rump steak, cut into strips
1/2 cup plain flour salt and pepper
1 onion, finely chopped
2 tablespoons tomato purée
1 1/2 cups beef stock
1/4 cup red wine
100 g mushrooms, thinly sliced
300 mL sour cream

1. Toss steak with flour, salt and pepper in a freezer bag until evenly coated.
2. Place steak, left-over flour, onion, tomato purée, beef stock and red wine in a 3 litre casserole dish.
3. Cook, covered, for 35 minutes on 550W, stirring twice during cooking.
4. Stir in mushrooms and sour cream. Cook for a further 4-5 minutes on 550W.
5. Serve with boiled rice.

CORNED BEEF

Serves 6-8

2 tablespoons brown sugar
2 tablespoons malt vinegar
3 cups hot water
1.5 kg corned beef

1. Place corned beef in a casserole dish just large enough to contain it.
2. Combine brown sugar, malt vinegar and hot water. Pour over corned beef.
3. Cover with lid and cook for 70 minutes on 550W, turning over halfway through cooking. Allow to stand covered with foil for 10 minutes before serving.
4. Serve with white sauce.

MEAT

CRUSTY ROSEMARY LAMB

Serves 4-6

1/4 cup brown sugar
2 tablespoons seeded mustard
1 tablespoon lemon juice
2 tablespoons chopped fresh rosemary
1.5 kg leg lamb

1. Combine brown sugar, mustard, lemon juice and rosemary in a small bowl.
2. Preheat oven to Convection 200°C.
3. Place lamb on the low rack and cook for 70 minutes at 200°C. Turn over half way.
4. Allow to stand 10 minutes covered with foil before carving.

SHEPHERD'S PIE

Serves 6-8

4 large potatoes (approx.1 kg)	1 tablespoon gravy powder
20 g butter	2/3 cup tomato sauce
1 tablespoon milk	1 tablespoon Worcestershire sauce
salt and pepper	1 tomato, chopped
1 kg minced beef	2 tablespoons parsley
1 onion, chopped	1 egg, beaten

1. Peel and cut potatoes into 2.5 cm cubes. Place in a large microwave safe bowl. Add 2 tablespoons water; cover and cook for 12-14 minutes on 1100W or until tender. Drain.
2. Mash potatoes; add butter, milk, salt and pepper.
3. In a large bowl, combine mince and onion and cook for 10-12 minutes on 770W, stirring every 2 minutes. Drain juices from meat.
4. Add gravy powder, tomato sauce, Worcestershire sauce, tomato and parsley. Mix well.
5. Spoon mixture into a 25 cm × 20 cm rectangular dish.
6. Spread mashed potato evenly over top of mixture. Brush with beaten egg.
7. Cook using the high rack on COMBI C-3 for 20-25 minutes, or until the top is crisp.
8. Allow to stand covered with foil for 10 minutes before serving.

LASAGNE

Serves 4-6

MEAT SAUCE INGREDIENTS

30 g butter
1 onion, chopped
1 kg topside mince
1/4 cup tomato paste
375 g jar bolognese sauce
280 g can champignons, drained
1 clove garlic, crushed (optional)

CHEESE SAUCE INGREDIENTS

90 g butter
1/3 cup flour
1 3/4 cups milk
125 g tasty cheese, grated
250 g packet instant lasagne sheets
100 g mozzarella cheese, grated

MEAT SAUCE METHOD

1. Place butter and onion in a microwave safe glass bowl. Cook for 2-3 minutes on 1100W.
2. Stir in mince. Cook, uncovered, for 12-14 minutes on 770W, stirring every 2 minutes. Drain excess fat.
3. Stir in tomato paste, bolognese sauce, champignons and garlic.

CHEESE SAUCE METHOD

1. Melt butter for 50-60 seconds on 1100W. Stir in flour; cook for further 1 minute on 1100W.
2. Gradually stir in milk. Cook for 4-6 minutes on 1100W, stirring every minute.
3. Stir in tasty cheese.

TO COMBINE

1. Use a 25 × 25 cm deep casserole dish.
2. Dip lasagne sheets in hot water, then cover base of dish.
3. Spoon over sheets one-third of meat sauce. Cover with one-third of cheese sauce.
4. Repeat the process 3 times, ending with the cheese sauce.
5. Sprinkle with mozzarella cheese.
6. Cook using the low rack on COMBI C-3 for 30-35 minutes.
7. Allow to stand 10 minutes before serving.
8. Serve with a fresh garden salad and bread.

APPETISERS

QUICK NACHOS

Serves 4

200 g packet corn chips
250 g jar of salsa
1/2 cup sour cream
2 tablespoons tomato paste
1/4 cup grated tasty cheese

1. Place corn chips in base of a glass pie dish.
2. Mix salsa and sour cream together in a small bowl. Pour over corn chips.
3. Spread tomato paste over the top of salsa.
4. Sprinkle with cheese.
5. Place on the low rack and cook for 6 1/2 minutes on GRILL.
6. Serve immediately with guacamole.

GARLIC AND HERB FOCACCIA

1 focaccia (rectangular)
100 g margarine
2 cloves garlic, crushed
1 teaspoon mixed herbs

1. Carefully cut bread in half.
2. Mix margarine, garlic and herbs together in a small bowl.
3. Spread evenly over focaccia. Place onto the high rack side by side.
4. Cook for 4-5 minutes on GRILL.
5. Cut into strips and serve hot.

VEGETABLE FRITTATA

Serves 4

2 large potatoes, peeled and thinly sliced
1 onion, thinly sliced
5 eggs
450 mL sour cream
330 g can asparagus spears, drained
1/2 red capsicum, cut into strips
2 zucchinis, cut into strips
2 tablespoons parmesan cheese

1. Arrange potatoes and onion over base of greased 23 cm glass pie plate.
2. Combine eggs and sour cream. Pour half the mixture over potatoes.
3. Place dish directly onto the turntable. Cook for 10-12 minutes on 770W.
4. Arrange asparagus, capsicum and zucchinis in a circle over potato. Pour over remaining egg mixture. Sprinkle with cheese.
5. Place dish directly on the turntable and cook for 18-20 minutes on 770W.
6. Stand covered with foil for 5 minutes.
7. Cut into wedges.

RECIPES

INDEX

APPETISERS

GARLIC AND HERB FOCACCIA	(11)
QUICK NACHOS	(11)
VEGETABLE FRITTATA	(11)

MEAT

APRICOT AND ALMOND CRUSTY LAMB	(16)
BEEF MADEIRA	(15)
BEEF STROGANOFF	(13)
BREAKFAST GRILL	(17)
CHILLI CON CARNE	(15)
CORNERED BEEF	(13)
CRUSTY ROSEMARY LAMB	(12)
CURRIED SAUSAGES	(13)
FILLET MIGNON	(16)
GRILLED KEBABS	(17)
HAMBURGER	(17)
HERBED LOIN OF LAMB	(14)
HONEY ROAST LAMB	(16)
ITALIAN SPAGHETTI SAUCE	(14)
LASAGNE	(12)
MINTED PICNIC LOAF	(15)
PORK RIBS WITH CHILLI PLUM SAUCE	(17)
SHEPHERD'S PIE	(12)
SPINACH LOIN OF LAMB	(16)
SPRINGTIME LAMB CASSEROLE	(13)
TROPICAL LAMB CURRY	(15)
VEAL À LA MEDALLION	(14)
VEAL AND PINEAPPLE	(14)

POULTRY

APRICOT CHICKEN	(20)
CHEESE AND HERB CHICKEN LEGS	(20)
CHICKEN AND APRICOT SALAD	(18)
CHICKEN AND MACARONI BAKE	(20)
CHICKEN CACCIATORE	(21)

POULTRY continued

CHICKEN FILLET BURGERS	(21)
CHICKEN FRICASSEE	(18)
CHICKEN IN A POT	(18)
CHICKEN PROVENCE	(19)
CHICKEN TERRINE	(19)
CHICKEN WITH BACON AND LEEK SEASONING	(18)
CRUNCHY CAMEMBERT CHICKEN	(21)
HONEY CHICKEN LEGS	(20)
ROAST CHICKEN	(21)
TANDOORI CHICKEN	(19)
WHOLEMEAL CHICKEN	(19)

SEAFOOD

BOUILLABAISSA	(25)
CHEESY SALMON CANNELLONI	(22)
CRAB MORNAY	(24)
CRISPY MARINATED CRAB STICKS	(23)
CURRIED SCALLOPS	(25)
GARLIC MUSSELS	(24)
GARLIC PRAWNS	(22)
MARINATED BABY OCTOPUS	(22)
OYSTERS KILPATRICK	(26)
PRAWN CUTLETS	(26)
PRAWN CREOLE	(23)
SCALLOPS IN BLACK BEAN SAUCE	(23)
SEAFOOD LASAGNE	(24)
SESAME PRAWNS	(24)
SQUID IN TOMATO AND WINE SAUCE	(25)
TAGLIATELLE AND CRAB SALAD	(23)

VEGETABLES

CAULIFLOWER AU GRATIN	(27)
CHUNKY VEGETABLE SOUP	(28)
EASY HOME-MADE RICE RISOTTO	(27)
GRILLED TOMATOES	(30)
GRILLED ZUCCHINI WITH FETA AND MINT	(29)

VEGETABLES continued

HONEY CARROTS	(27)
HONEY GINGERED VEGETABLES	(29)
POTATOES PIZZAIOLA	(30)
POTATO, AVOCADO AND ONION SALAD	(28)
PUMPKIN SALAD	(30)
ROAST VEGETABLES	(29)
SCALLOPED POTATOES	(27)
SOY AND SESAME GREEN BEANS	(30)
SQUASH WITH YOGHURT	(29)
STUFFED BAKED POTATOES	(28)
STUFFED MUSHROOMS	(28)
VEGETABLE PLATTER	(27)

DESSERTS

APRICOT WHEATGERM CRUNCHIES	(33)
AUSTRALIAN FRUIT CAKE	(31)
BAKED APPLES	(31)
BREAD AND BUTTER PUDDING	(32)
CALIFORNIAN APPLE CRUNCH	(31)
CARAMEL RICE PUDDING	(32)
CHOCOLATE MOUSSE	(32)
CHOCOLATE CAKE	(31)
CHOCOLATE CHIP COOKIES	(33)
CHOCOLATE SELF-SAUCING PUDDING	(32)
MUESLI CUSTARD DELIGHT	(33)

CHARTS

DEFROSTING CHARTS	(34)
FRESH VEGETABLE CHART	(35)
FROZEN VEGETABLE CHART	(36)
CONVECTION CHART	(38)
GUIDE TO COOKING EGGS	(36)
REHEATING CONVENIENCE	
DEFROSTING CONVENIENCE-FOOD CHART	(37)
ROAST MEAT AND POULTRY CHART	(39)
RICE AND PASTA COOKING CHART	(36)

INVERTER MICROWAVE COOK MENU GUIDE

**RICE/
PASTA**

To use the following menus, press RICE/PASTA until the desired menu appears on the display.

Menu	Weight Range				Initial Temperature (approx.)	Procedure	Stirring Time *Time shows on display
White Rice	1 - 4 Cups				+40°C Hot tap water	- Place into a microwave safe glass bowl and cover with hot tap water. - Cook uncovered. - When the oven stops, stir and continue cooking. - After cooking, stand for 2 minutes and stir.	around 7:30~12:30
	Rice	1 Cup	2 Cup	4 Cup			
	Hot tap water	2 Cups	4 Cups	6 Cups			
Brown Rice	1 - 4 Cups				+40°C Hot tap water	- Place into a microwave safe glass bowl and cover with hot tap water. - Cook uncovered. - When the oven stops, stir and continue cooking. - After cooking, stand for 2 minutes and stir.	around 13:15~24:30
	Brown Rice	1 Cup	2 Cup	4 Cup			
	Hot tap water	2 Cups	4 Cups	6 Cups			
Pasta	100 - 400g				+40°C Hot tap water	- Place into a microwave safe glass bowl and cover with hot tap water. - Cook uncovered. - When the oven stops, stir and continue cooking. - After cooking, stand for 2 minutes and stir.	around 8:30~12:30
	Pasta	100g	200g	400g			
	Hot tap water	2 Cups	4 Cups	6 Cups			
Wholemeal Pasta	100 - 400g				+40°C Hot tap water	- Place into a microwave safe glass bowl and cover with hot tap water. - Cook uncovered. - When the oven stops, stir and continue cooking. - After cooking, stand for 2 minutes and stir.	around 7:00~10:00
	Wholemeal Pasta	100g	200g	400g			
	Hot tap water	2.5 Cups	4.5 Cups	6.5 Cups			

INVERTER MICROWAVE COOK MENU GUIDE

MELT/ SOFTEN

To use the following menus, press MELT/SOFTEN until the desired menu appears on the display.

Menu	Weight Range	Initial Temperature (approx.)	Procedure	Stirring Time *Time shows on display
Chocolate	100 -250g	+20°C Room Temperature	- Break chocolate into cubes and place into a microwave safe glass bowl. - Cook uncovered. - When the oven stops, stir and continue cooking.	around 1:00~1:15
Butter	100 -250g	+3°C Refrigerated	- Chop butter into cubes and place into a microwave safe glass bowl. - Cook uncovered. - When the oven stops, stir and continue cooking.	around 0:41~1:02
Cream Cheese	100 -250g	+3°C Refrigerated	- Chop cream cheese into cubes and place into a microwave safe glass bowl. - Cook uncovered. - When the oven stops, stir and continue cooking.	around 0:15~0:23

VEGETABLES/ QUINOA

To use the following menus, press VEGETABLES/QUINOA until the desired menu appears on the display.

Menu	Weight Range	Initial Temperature (approx.)	Procedure	Turn over/Stirring Time *Time shows on display						
Fresh Vegetables	150 - 500g	+3°C Refrigerated	- Wash the vegetables. - Place into a microwave safe glass bowl with 1 tablespoon of water. - Cook uncovered. - After cooking, stand for 2 minutes.	-						
Frozen Vegetables	150 - 500g	-18°C	- Place into a microwave safe glass bowl. - Cook uncovered. - After cooking, stand for 2 minutes.	-						
Sweet Jacket Potato	1 - 2 Sweet Potatoes	+20°C Room Temperature	- Use washed and dried sweet potatoes. - Pierce the skin twice with a fork on each side. - Place directly onto the turntable. - When oven stops, turn over and continue cooking. - After cooking, stand for 2 minutes.	around 3:30~7:00						
Quinoa	1 - 2 Cups <table border="1" style="display: inline-table; vertical-align: middle;"> <tr> <td>Quinoa</td> <td>1 Cup</td> <td>2 Cups</td> </tr> <tr> <td>Hot tap water</td> <td>2 Cups</td> <td>4 Cups</td> </tr> </table>	Quinoa	1 Cup	2 Cups	Hot tap water	2 Cups	4 Cups	+40°C Hot tap water	- Wash quinoa until water runs clear. - Place into a microwave safe bowl and cover with hot tap water. - Cook uncovered. - When the oven stops, stir and continue cooking. - After cooking stand for 5 minutes and stir.	around 8:00~10:30
Quinoa	1 Cup	2 Cups								
Hot tap water	2 Cups	4 Cups								

CONVENIENCE MENU GUIDE

PREHEAT To use the following menus, press REHEAT until the desired menu appears on the display.

Menu	Weight Range	Initial Temperature (approx.)	Procedure
Reheat Plate	1 Serve (approx. 400g)	+3°C Refrigerated	- Cover with plastic wrap. Pierce plastic wrap with a fork.
	Meat 200g Vegetables 200g		
Reheat Beverage	1 Cup (approx. 250ml)	+20°C Room Temperature	- Use a microwave safe mug.

DEFROST To use the following menus, press DEFROST until the desired menu appears on the display.

Menu	Weight Range	Initial Temperature (approx.)	Procedure	Turn over Time *Time shows on display
Mince	0.5 - 1kg	-18°C	- Place mince on a defrost rack. - When the oven stops, turn over and shield warm portions with foil strips. - After defrost time, stand covered with foil for 10-15 minutes.	around 1:28~2:52
Steak / Chops	0.5 - 1kg	-18°C	- Place steak / chops on a defrost rack. - When the oven stops, turn over and shield warm portions with foil strips. - After defrost time, stand covered with foil for 10-15 minutes.	around 1:30~2:35
Roast Meat	1 - 2kg	-18°C	- Place roast meat on a defrost rack. - When the oven stops, turn over and shield warm portions with foil strips. - After defrost time, stand covered with foil for 15-20 minutes.	around 3:45~4:45
Whole Chicken	1 - 2kg	-18°C	- Remove from original packaging. Shield wing and leg tips with foil. - Place breast side down on defrost rack. - When the oven stops, turn over and shield warm portions with foil. - After defrost time, stand covered with foil for 15-20 minutes.	around 5:30~10:00
Chicken Fillet	0.5 - 1kg	-18°C	- Place chicken fillets on a defrost rack. - When the oven stops, turn over and shield warm portions with foil strips. - After defrost time, stand covered with foil for 10-20 minutes.	around 2:45~4:27
Fish Fillet	0.5kg	-18°C	- Place fish fillets on a defrost rack. - When the oven stops, turn over and shield warm portions with foil strips. - After defrost time, stand covered with foil for 5 minutes.	around 2:25

FAN FORCED COOK MENU GUIDE

ROAST

To use the following menus, press ROAST until the desired menu appears on the display.

Menu	Weight Range	Initial Temperature (approx.)	Procedure	Turn over Time *Time shows on display
Roast Chicken	1 - 2kg	+3°C Refrigerated	- Place chicken on the low rack. - When the oven stops, turn over the chicken and continue to cook. - After cooking, stand covered with foil for 15-20 minutes.	around 20:00~40:00
Roast Beef	1 - 2kg	+3°C Refrigerated	- Place beef on the low rack. - When the oven stops, turn over the beef and continue to cook. - After cooking, stand covered with foil for 15-30 minutes.	around 25:00~45:00
Roast Lamb	1 - 2kg	+3°C Refrigerated	- Place lamb on the low rack. - When the oven stops, turn over the lamb and continue to cook. - After cooking, stand covered with foil for 15-30 minutes.	around 25:00~45:00
Roast Pork	1 - 2kg	+3°C Refrigerated	- Place pork on the low rack. - When the oven stops, turn over the pork and continue to cook. - After cooking, stand covered with foil for 15-20 minutes.	around 32:30~64:10

BAKE

To use the following menus, press BAKE until the desired menu appears on the display.

Menu	Weight Range	Initial Temperature (approx.)	Procedure
Butter Cake	1 Cake	+20°C Room Temperature	Recipe: Ingredients: 180g salted butter, softened ¾ cup caster sugar 2 eggs 1 tablespoon vanilla essence 1 ½ cups self raising flour ½ cup milk Method: 1) In a large bowl beat the butter and sugar together until light and fluffy. 2) Add vanilla essence and eggs, beat until well combined. 3) Add the flour and milk, fold through the mixture until well combined. 4) Transfer mixture to a lined 21cm cake tin and place on the low rack. 5) After cooking, allow cake to stand for 10 minutes before turning out onto a wire rack to cool.
Frozen Lasagne	1 Serve (approx. 400g)	-18°C	- Remove lasagne from original packaging and transfer to an oven safe dish. - Cook on the low rack.







FAN FORCED COOK MENU GUIDE

AIRFRY

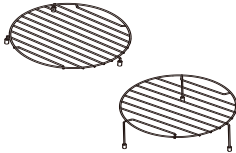
To use the following menus, press MEAT PIE until the desired menu appears on the display.

Menu	Weight Range	Initial Temperature (approx.)	Procedure	Turn over Time *Time shows on display
Frozen French Fries	200g	-18°C	- Remove frozen french fries from original packaging and place directly onto the grill tray on the high rack. - When the oven stops, take out the french fries.	-
Frozen Potato Gems	400g	-18°C	- Remove frozen potato gems from original packaging and place directly onto the grill tray then place the grill tray on the high rack. - When the oven stops, take out the potato gems.	-
Frozen Squid	250g	-18°C	- Remove the frozen squid from original packaging and place directly onto the grill tray then place the grill tray on the high rack. - When the oven beeps for 4 times and stop, turn over the squid and continue to cook. - When the oven stops, take out the squid.	around 7:00
Frozen Onion Rings	200g	-18°C	- Remove frozen onion rings from original packaging and place directly onto the grill tray then place the grill tray on the high rack. - When the oven beeps for 4 times and stop, turn over the onion rings and continue to cook. - When the oven stops, take out the onion rings.	around 6:00
Frozen Chicken Nuggets	360g	-18°C	- Remove frozen chicken nuggets from original packaging and place directly onto the grill tray then place the grill tray on the high rack. - When the oven stops, take out the chicken nuggets.	-
Frozen Schnitzel	280g	-18°C	- Remove frozen schnitzel from original packaging and place directly onto the grill tray then place the grill tray on the high rack. - When the oven beeps for 4 times and stop, turn over the schnitzel and continue to cook. - When the oven stops, take out the schnitzel.	around 10:00
Frozen Crumbed Prawns	230g	-18°C	- Remove frozen crumbed prawns from original packaging and place directly onto the grill tray then place the grill tray on the high rack. - When the oven beeps for 4 times and stop, turn over the crumbed prawns and continue to cook. - When the oven stops, take out the crumbed prawns.	around 4:00
Fresh Vegetables	240g	20°C	- Cut desired vegetables into small bite size, apply oil and season. - Place directly onto the grill tray then place the grill tray on the high rack. - When the oven stops, take out the vegetables.	-
Frozen Spring Rolls	250 g	-18°C	- Remove frozen spring rolls from original packaging and place directly onto the grill tray then place the grill tray on the high rack. * If you use uncooked products, please apply oil on them before cooking. - When the oven beeps for 4 times and stop. turn over the spring rolls and continue to cook. - When the oven stops, take out the spring rolls.	around 5:00

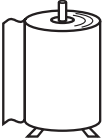
COOKWARE & UTENSIL GUIDE

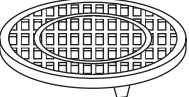
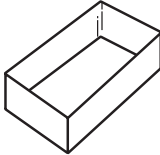
		MICROWAVE	GRILL	COMBI COOKING	CONVECTION	
						
OVENPROOF GLASS	METAL RACKS					
						
CAKE TIN	GRILL TRAY					
						
RING CENTRE DISH	PIZZA TRAY					
						
PAPER TOWEL	FOIL					
						
DEFROST RACK	SQUARE DISH					
		METAL RACKS / GRILL TRAY	NO	YES	YES (C2 & C3 only)	YES
		GLASSWARE/CERAMIC (HEAT RESISTANT)	YES	YES	YES	YES
		METAL COOKWARE	NO	YES	*1 YES (C2 & C3 only)	YES
		OVEN BAGS	YES	NO	NO	NO
		ALUMINIUM FOIL	For Shielding	YES	For Shielding	YES
		NON-STICK PAPER	YES	NO	NO	NO
		GREASE-PROOF PAPER	YES	NO	NO	NO
		WAXED PAPER	YES	NO	NO	NO
		PLASTIC WRAP	*2 YES (microwave safe wrap only)	NO	NO	NO
		PAPER TOWEL	YES	NO	NO	NO
		PLASTIC COOKWARE MICROWAVE SAFE	*3 YES	NO	NO	NO
		BROWNING DISH	YES	NO	NO	NO
		DEFROST RACK	Defrost Only	NO	NO	NO
		THERMOMETERS MICROWAVE SAFE	YES	NO	NO	NO
		CONVENTIONAL	NO	NO	NO	NO

*1 When using metal utensil, place a heat resistant dish between the metal utensil and the rack (refer to page ③).

*2 For cooking food with high fat contents, do not bring the wrap in contact with the food as it may melt.

*3 Some microwave safe plastic cookware are not suitable for cooking foods with high fat and sugar content.

NOTE: See pages 5 and 6 for the accessories that are provided with your oven. For other cookware, please use commercially available products.

HELPFUL HINTS

GRILL COOKING

1. Use thick oven mittens when removing the food or turntable from the oven to PREVENT BURNS. Because the oven cavity, door, turntable, roller stay, racks, grill tray, dishes and especially the grill will become very hot.
2. Foods may be cooked either directly on turntable, or using the high or low racks.

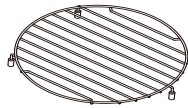

LOW RACK

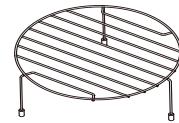

HIGH RACK

COMBI COOKING

1. There are four automatic, preprogrammed combi settings.

COMBI	C-1	C-2	C-3	C-4
	Microwave+Convection	Microwave+Grill	Grill+Convection	Microwave+Grill+Convection
Microwave	•	•		•
Grill		•	•	•
Fan-Forced Convection	•		•	•

2. Use thick oven mittens when removing the food or turntable from the oven to PREVENT BURNS. Because the oven cavity, door, turntable, roller stay, racks, grill tray, dishes and especially the grill will become very hot.
3. Metal cookware can be used.

During combi cooking some metal utensils may cause arcing when they come in contact with oven walls or accessory racks. To prevent arcing when using a metal tin, place a heat resistant dish (microwave safe glass pie plate, dinner plate) between the tin and the rack.



CAKE TIN



PIZZA TRAY

CONVECTION COOKING

1. Use thick oven mittens when removing the food or turntable from the oven to PREVENT BURNS. Because the oven cavity, door, turntable, roller stay, racks, grill tray and dishes will become very hot.
2. For best results, preheat to required temperature with the turntable in the oven. Add food after preheating.
3. Metal cookware can be used. Round pizza trays are excellent cooking utensils for cooking.

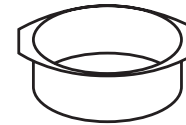

CAKE TIN

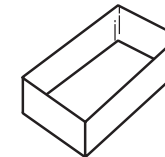

SQUARE DISH



PIZZA TRAY

4. If you are cooking and wish to check the temperature you have programmed, simply press the FAN FORCED CONVEC. pad. The programmed temperature will be displayed as long as FAN FORCED CONVEC. pad is pressed.
5. Do not cook 2 layers of e.g. biscuits at the same time.

HELPFUL HINTS

MICROWAVE COOKING

1. ARRANGEMENT

Arrange foods carefully. Place thickest areas toward outside of dish.

E.g. Arrange vegetables in a shallow dish in the following way:

Hard Vegetables around the outside, Soft Vegetables in the centre, Medium Vegetables in-between.



2. TURNING

Foods such as poultry and joints of meat should be turned over after half the cooking time.

3. COVERING

Cover foods in the microwave if you would normally cover the food in your ordinary oven, or to retain moisture. Cover foods such as Vegetables, Casseroles, or when Reheating.

Use to cover foods:



LID



PLASTIC WRAP

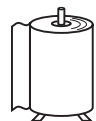

PAPER TOWEL

4. PIERCING

Pierce potatoes, eggs, oysters, tomatoes or any foods with a skin or membrane to allow steam to escape.



TOMATO



EGG

5. SHIELDING

Shield using small pieces of aluminium foil to shield thin areas of meat, fish and poultry or edges of cakes to prevent overcooking.



FISH



CHICKEN

6. STANDING TIME

Standing time is important. After cooking or defrosting ensure adequate standing time. This allows the food to continue cooking or heating. Refer to cooking guides for each menu or according to manufacturers instructions.

7. STIRRING

Stir foods from the outside to the centre of the dish, once or twice during cooking if possible.

E.g. Casseroles and Sauces.



STIR

8. SIZE

Small pieces cook faster than large ones. To speed cooking, cut pieces smaller than 5cm so microwaves can penetrate to the centre from all sides. For even cooking, make all the pieces the same size.

9. DENSITY

The depth to which microwaves penetrate food varies depending on the food's density. Porous foods like minced beef or mashed potatoes microwave faster than dense ones like steak or whole potatoes.

10. FAT AND BONE

Marbling within meat, or a thin, even layer of fat on a roast, speeds cooking. Large fatty areas or excess drippings in a dish attract energy away from meat, and slows cooking. Centre bones do not affect cooking, but bone on the side of meat conducts heat to the areas next to it.

11. STARTING TEMPERATURE

Frozen or refrigerated food takes longer to heat than food at room temperature. Cooking times in this manual are based on normal storage temperatures. Since rooms, refrigerators and freezers differ in temperature, check for doneness at the minimum time.



12. QUANTITY

Microwave cooking times are directly related to the amount of food in the oven. Because energy is absorbed by the food itself, one potato or a single piece of chicken cooks rapidly. When the energy is divided among several items, cooking takes more time.

13. CONDENSATION

Condensation is a normal part of microwave cooking. The humidity and moisture in food will influence the amount of condensation in the oven.

Generally, covered foods will not cause as much condensation as uncovered foods. Ensure that the ventilation openings are not blocked.

14. GENERAL

Your microwave oven is capable of heating food and beverages very quickly therefore, it is very important that you select the appropriate cooking time and power level for the type and quantity of food to be heated. If you are unsure of the cooking time and power level required, begin with low cooking times and power levels until the food is sufficiently heated evenly throughout.

QUICK REFERENCE GUIDE

FEATURE	QUICK OPERATION GUIDE
Defrost e.g. Roast Meat	<p>DEFROST x3 → START +30SEC. → Weight 1 0 0 → START +30SEC. e.g. 1.0kg</p>
Reheat e.g. Beverage 1 Cup	<p>PREHEAT x2 → START +30SEC.</p>
Variable Cooking Control	<p>To soften Cream Cheese or Butter for 40 seconds at 330W power level (M • LOW).</p> <p>MICROWAVE WATTAGE x8 → START +30SEC. → Cooking Time 4 0 → START +30SEC. e.g. 40 seconds</p>
Preheat and Cook by Convection	<p>PREHEAT → Temp 5 170°C → START +30SEC. → Cooking Time 2 0 0 0 → START +30SEC. e.g. 170°C e.g. 20 minutes</p>
Manual Convection Cooking	<p>FAN FORCED CONVEC. → Temp 6 180°C → START +30SEC. → Cooking Time 1 5 0 0 → START +30SEC. e.g. 180°C e.g. 15 minutes</p>
Grill Cooking	<p>Grill Mode GRILL → Cooking Time 1 5 0 0 → START +30SEC. e.g. 15 minutes</p>
Combi Cooking	<p>Combi Setting COMBI x1 → START +30SEC. → Cooking Time 1 5 0 0 → START +30SEC. e.g. Microwave and Convec. e.g. 15 minutes</p>

SMART COOKING GUIDES CONTENTS

Quick Reference Guide ①	Helpful Hints ② - ③	Cookware & Utensil Guide ④	Fan Forced Cook Menu Guide ⑤ - ⑥	Convenience Menu Guide ⑦	Inverter Microwave Cook Menu Guide ⑧ - ⑨	Recipes ⑩ - ⑳
-------------------------	---------------------	----------------------------	----------------------------------	--------------------------	--	---------------